

AM · FM · TELEVISION

BROADCAST NEWS

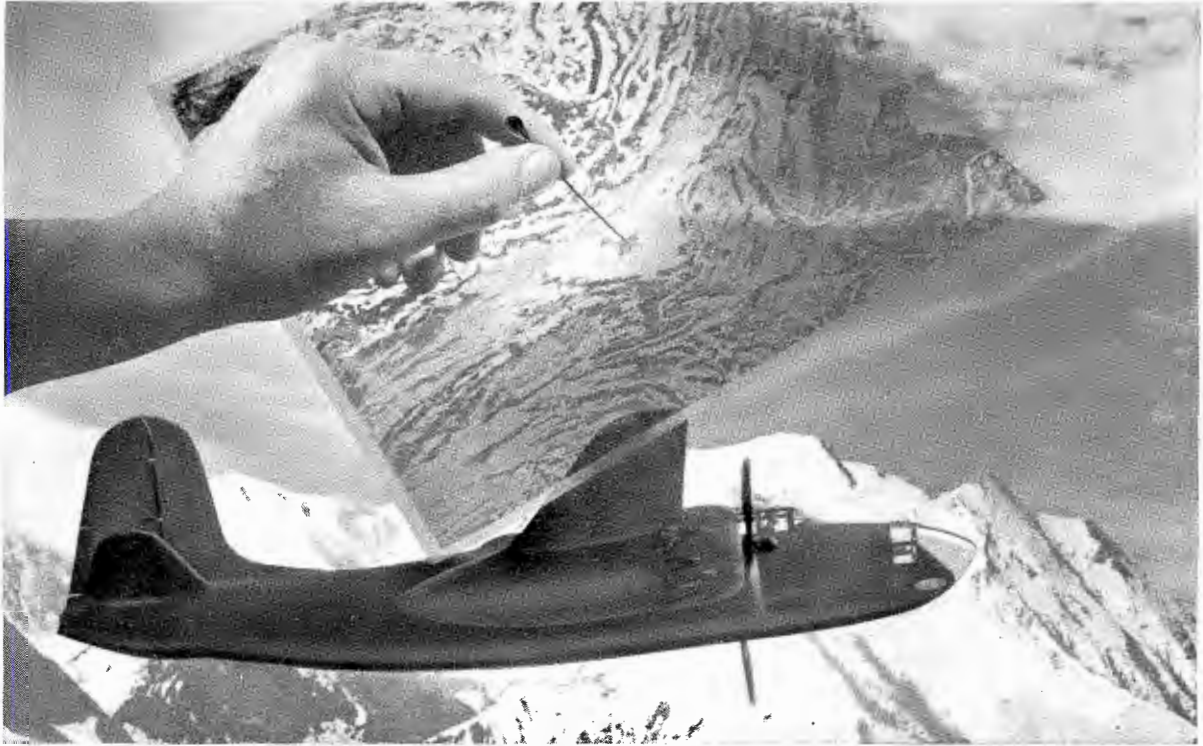

THE NEW IMAGE ORTHICON CAMERA . . . See Pg. 6



Developed by RCA as an aid to blind bombing in wartime, SHORAN is a new radar yardstick for world mapping.

SHORAN - a surveying system with pin-point accuracy!

Measures to an accuracy of 25 feet in 100 miles in less time than it takes to tell it

With SHORAN, considered the most accurate radar system yet devised, vast areas can now be charted by plane in a matter of hours. Error is reduced practically to the vanishing point!

Developed by RCA for the Army Air Forces shortly before the war ended, as an aid in pin-point bombing, SHORAN helped establish phenomenal records for accuracy under conditions making visual bombing impossible.

SHORAN also has important peacetime applications. The surveying of offshore oil and inaccessible mineral deposits can be done with uncanny accuracy. Mountains and other natural obstacles, which often make conven-

tional charting methods difficult or impossible, are no longer a hindrance.

Here, briefly, is how SHORAN works: Two portable SHORAN stations are located on land or on shipboard, at known points, some distance apart. These form the base of a triangle. A SHORAN-equipped boat or plane—the apex of the triangle—transmits radar pulses within a radius of 30 to 250 miles. The fixed stations pick up these pulses, amplify them, and send them back to the boat or plane, each station causing a corresponding spot to appear on a fluorescent screen in the boat or plane.

The relative positions of these spots enable the operator—by means of calibrated dials—to determine by simple triangulation his exact position. Accuracy is within a few feet; the answer is found in a matter of seconds!

This new tool is another RCA development—the result of the kind of research and engineering that *you* can count on for your electronic communications requirements. Radio Corporation of America, Government Equipment Section, Camden, New Jersey.

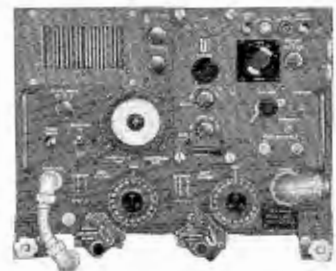

RCA SHORAN for aircraft is extremely compact equipment taking no more space than that required for the average aircraft transmitter.



GOVERNMENT EQUIPMENT SECTION
RADIO CORPORATION of AMERICA
ENGINEERING PRODUCTS DEPARTMENT, CAMDEN, N. J.

In Canada: RCA VICTOR Company Limited, Montreal

Broadcast News

AM • FM • TELEVISION

Published by the
RADIO CORPORATION OF AMERICA
ENGINEERING PRODUCTS DEPARTMENT . . . CAMDEN, NEW JERSEY

NUMBER 44

OCTOBER, 1946

JOHN P. TAYLOR, Editor

JUDY J. ALES, Ass't Editor

Contents

THE TK-30A CAMERA	by NORMAN S. BEAN	6
RCA WAR RESEARCH	by LOREN F. JONES	14
MICROWAVE EQUIPMENT FOR TELEVISION RELAY SERVICE	by W. J. POCH AND J. P. TAYLOR	20
RCA SALES ORGANIZATION		28
THE "PYLON" ANTENNA	by R. F. HOLTZ	36
ISOLATION METHODS FOR FM ANTENNAS MOUNTED ON AM TOWERS	by R. F. HOLTZ	42
PLUG-IN AMPLIFIERS	by H. DUSZAK	44
THE BTF-10B TRANSMITTER	by J. E. YOUNG	56
THE BTF-50A TRANSMITTER	by C. J. STARNER	60
DETERMINING THE POPULATION SERVED BY AN FM STATION		63
GROUNDING-GRID POWER AMPLIFIERS	by E. E. SPITZER	66

Printed in U. S. A.

Copyright, 1946, Radio Corporation of America

OUR COVER for this issue is the work of Norman Bean of our Television Engineering Group. And we say that advisedly, for Norman (a) conceived the idea for the interesting setting using the small figurines, (b) took the camera home and made the photo in his basement studio (he only took about twenty shots before he got one that satisfied him) and (c) developed the color transparency himself; which, during August in Philadelphia (and without air-conditioning), is quite a feat.

INCIDENTALLY, we would like to see any really good color shots you may have taken of your station. It is our desire to make each cover just as interesting as possible and you may have the photos to do it. It doesn't have to be an equipment picture—the only requirement is that it be of interest to your fellow broadcasters. Transparencies will do—we make the plates directly from them.

THE TK-30A CAMERA comes in for a lot of attention in this issue—and rightly so, we think. This new camera—the first postwar design to be produced in quantity (some 25 already shipped) seems to have everything. It's simple to operate, has far greater sensitivity than any other type, and is ruggedly built. Designed originally for field use, it now appears that it will also be very suitable for studio use. Our enthusiasm (and the enthusiasm of most telecasters who have seen it) is almost unlimited. We think it will occupy a place in telecasting which is equivalent to that of the 44-B Velocity Microphone in broadcasting.

Credit for the development and design of the TK-30A Camera goes to the engineering group headed by M. A. Trainer and including J. H. Roe, H. M. Potter, J. M. Brunbaugh, S. L. Bendell, and Norman Bean.

267 YEARS of broadcast experience is represented by the 21 RCA transmitter sales engineers whose pictures are shown on Pages 30 to 35. That's an average of better than 13 years per man—and yet they're all relatively young men. What's the answer? Simple, they are all born and bred radio men. Without exception they started in radio while still in the knee-pants stage. We like them that way! It insures our customers that the RCA transmitter sales engineer (not salesman!) with whom they come in contact will have an enthusiastic interest in their job—and that, in addition, he will have the experience to be genuinely helpful in solving equipment and installation problems. Some of these RCA sales engineers are new to their present jobs—but only a few are new to RCA, and all are imbued with the idea of reestablishing and carrying on RCA's prewar reputation for *plus* service. Most of you know what that means—those of you who don't should find out.

BILL BELTZ, who before the war was in charge of RCA broadcast sales on the West Coast, is now a Captain in the regular Navy. Bill was a Lt. Commander in the Reserve when he was called to active service early in 1941. Of the many radio men who served as electronics officers in the Navy during the war some five or six rose to the rank of Captain, but so far as we know, Bill is the only one to have been offered that rank in the regular Navy. He is now assigned to the Navy's Panama Canal District as Industrial Manager, an assignment of considerable importance and one never previously given to an electronics officer. While this presumably means that Bill will not return to RCA, as we had hoped, we are, nevertheless, very proud of him—and proud of the recognition which his advancement has given to the electronics profession!

TO "BAKE." This issue of BROADCAST NEWS will be ready for the NAB Convention—in other years we've called it our convention issue. It was always a pleasant time of the year—getting ready for the big show, looking forward to renewing old acquaintances, planning a very businesslike schedule which never quite seemed to work itself out! And, right in the middle of it all was Bake—father, brother, and counselor to all of us—and half the industry. This year's convention should be the largest ever—and we'll be there with more equipment, more men, and more new items than ever before. The tradition, the friendliness, the service will go on—and the equipment will be even better. But, for the old-timers among us—and for many of you—there will be a difference. In short—we miss you, "Bake!"

20 TOP BROADCASTERS

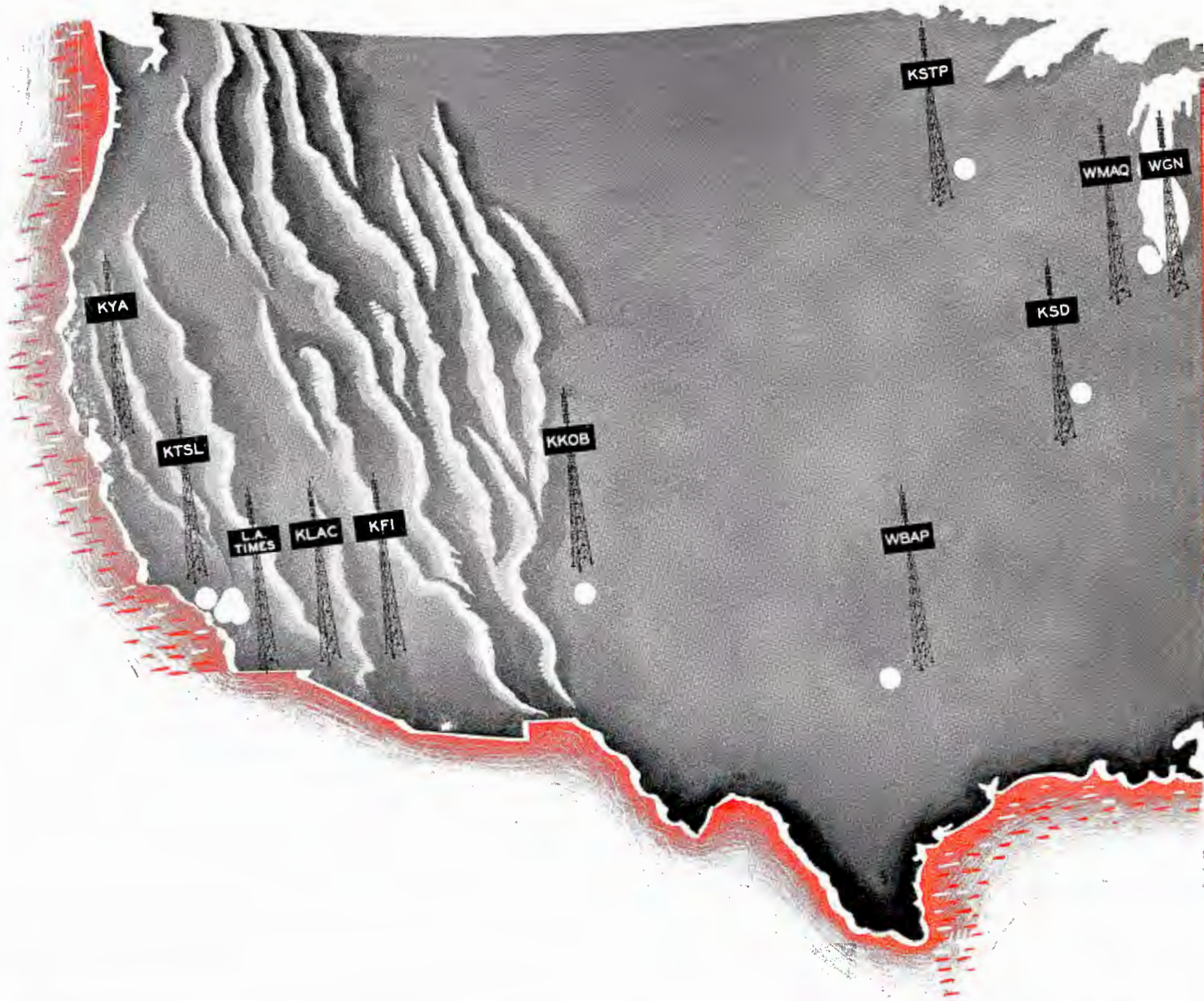

Get your television station started now with this fully developed, in-production line of RCA equipment

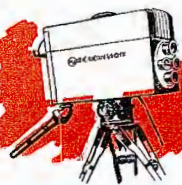

Remote Pick-up
Equipment



Relay
Equipment



Film
Equipment

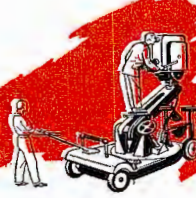

Studio
Equipment



Control-room
Equipment



Transmitting
Equipment



Antennas

take the lead in television

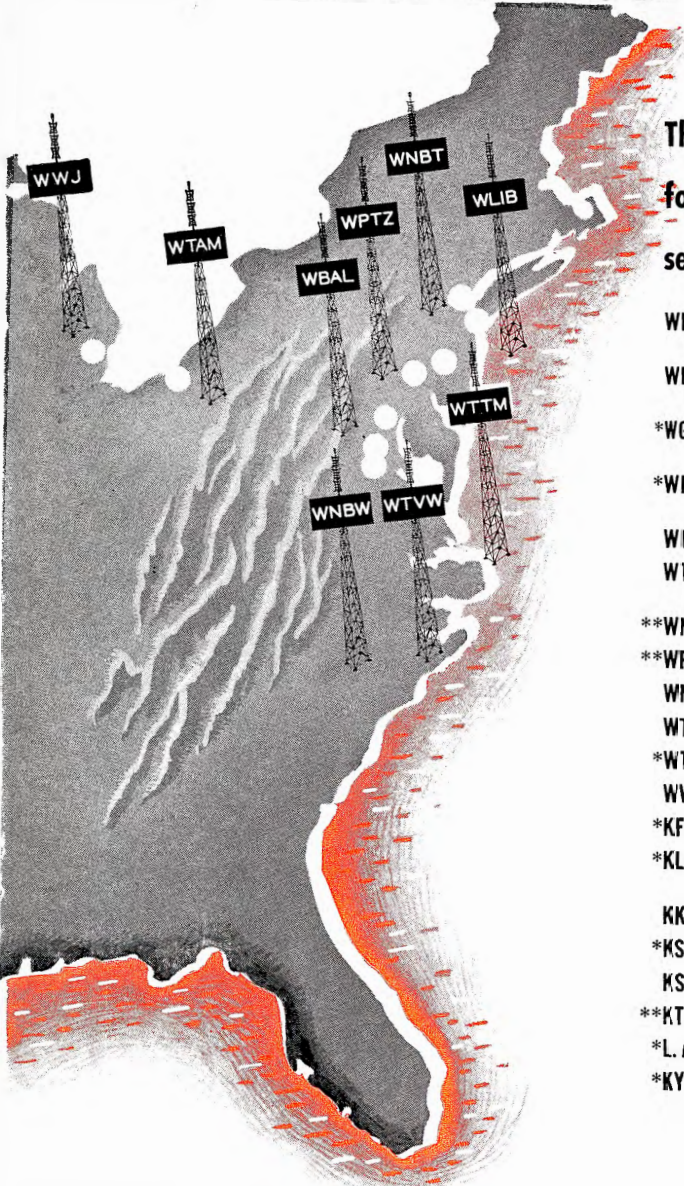

The broadcasters listed below have placed firm orders for RCA Television Equipment and will provide television service to a combined audience of 34,000,000 people

- WBAL—Hearst Radio, Inc., Baltimore, Md. Owned by Hearst newspapers and publications including "Baltimore News-Post," and others.
- WBAP—Carter Publications Inc., Fort Worth, Texas. Publishers of "The Fort Worth Star-Telegram."
- *WGN—WGN, Inc., Chicago, Ill. Subsidiary of The Tribune Co., publishers of "Chicago Tribune."
- *WLIB—WLIB, Inc., Brooklyn, N.Y. Owned by Theodoro Corp., Dorothy S. Thackrey, Pres., publisher "New York Post."
- WMAQ—National Broadcasting Co., Inc., Chicago, Ill.
- WTVW—Evening Star Broadcasting Co., (WMAL), Washington, D. C., Subsidiary of "The Evening Star."
- *WNBT—National Broadcasting Co., Inc., New York, N. Y.
- *WPTZ—Philco Television Broadcasting Corporation, Philadelphia, Pa.
- WNBW—National Broadcasting Co., Inc., (WRC), Washington, D. C.
- WTAM—National Broadcasting Co., Inc., Cleveland, Ohio.
- *WTTM—Trent Broadcast Corp., Trenton, N. J.
- WWJ—Evening News Association, Detroit, Mich., publishers of "The Detroit News."
- *KFI—Earl C. Anthony, Inc., Los Angeles, Calif.
- *KLAC—(Formerly KMTR), Los Angeles, Calif. Owned by Dorothy S. Thackrey, publisher of "New York Post."
- KKOB—Albuquerque Broadcasting Co., (KOB), Albuquerque, New Mexico.
- *MSD—Pulitzer Publishing Co., St. Louis, Mo.,—"St. Louis Post-Dispatch."
- KSTP—KSTP, Inc., Minneapolis/St. Paul, Minnesota.
- *KTSL—Don Lee Broadcasting System, Hollywood, Calif.
- *L. A. TIMES—"Los Angeles Times," published by the Times-Mirror Co., Los Angeles.
- *KYA—San Francisco. Owned by Dorothy S. Thackrey, publisher of "New York Post."

*Construction subject to FCC approval
 **Already broadcasting on a regular schedule

THE companies listed above have indicated by firm orders that they are anxious to start telecasting immediately and have authorized us to say that they plan to start as soon as their equipment is ready and FCC approval is granted. It is interesting to note that ten of the stations are owned by publishers.

The coming months should see all of these stations bringing television programs to their respective areas. Almost every item necessary for a television station has now been fully developed by RCA. Most equip-

ments are now in production. Deliveries have already begun on such items as monoscope cameras and synchronizing generators. Shipments on existing orders for portable field equipment, relays, antennas, 5-kw transmitters, and studio equipment will begin this fall.

It will pay you to investigate RCA television equipment immediately, so that you will also be ready to explore the tremendous potential promised by this new market. Write: Engineering Products Department, Sec. , Radio Corporation of America, Camden, N. J.



TELEVISION BROADCAST EQUIPMENT
RADIO CORPORATION of AMERICA
ENGINEERING PRODUCTS DEPARTMENT, CAMDEN, N.J.

In Canada: RCA VICTOR Company Limited, Montreal

8 FREE GUIDES

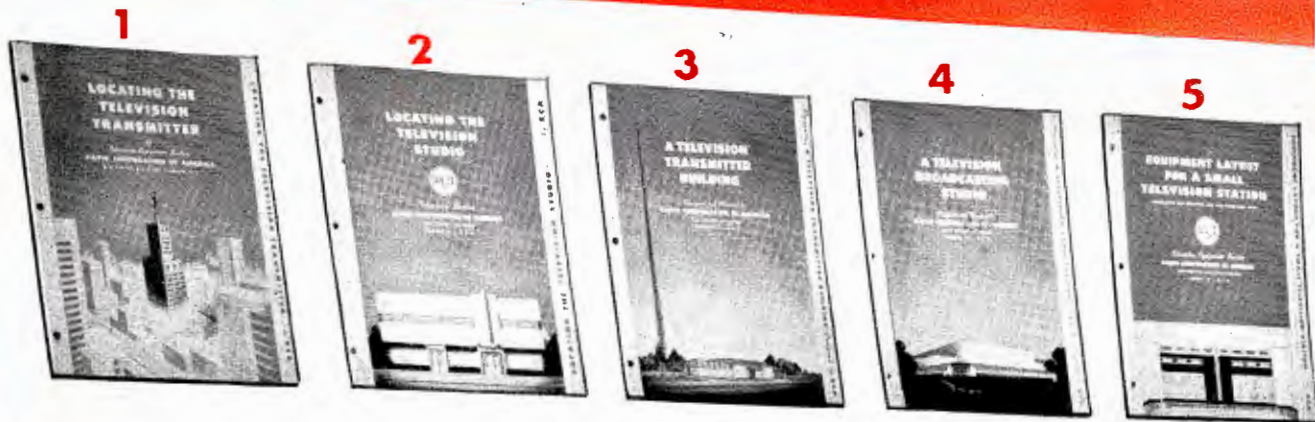

1 Locating the Television Transmitter

Covers factors governing the choice of site, technical requirements, importance of central location, importance of height, calculation of coverage, various types of sites (tall buildings, mountain tops, existing AM station locations, low buildings with a steel tower, television and FM transmitter at same site using a common antenna).

2 Locating the Television Studio

Discusses and illustrates such subjects as: space required for operations, cost of land and buildings, provision for future expansion, freedom of interference, power and water facilities, nearness to outside program sources, and location with relation to transmitter.

3 A Television Transmitter Building

Present indications are that most new transmitters will be located, wherever possible, in existing city buildings. However, if you plan to build a special transmitter building now, or in the future, this publication offers practical

suggestions on exterior appearance and floor plans. Covers general requirements, transmitter room, video receiving room, visitors' lobby, laboratory and shop, storage space, living quarters, and other provisions.

4 A Television Broadcast Studio

Typical headings include: number of studios required, size and shape of studios, acoustics and lighting, separate control booths, film studio, master control room, audience, and studio-transmitter link.

5 Equipment Layout for a Small Television Station

(with provision for network and film programs only.)

Publications 5, 6, 7, and 8 present a complete program on how your television station can grow in easy stages—low investment and operating costs in the initial period, gradual expansion later as your television audience grows. Leaflet 5 covers the minimum layout required to start telecasting.

6 Equipment Layout for a Small Television Station

(with provision for live-talent studio

programs and remote field pick-ups.)

This booklet presents Stage 2—the addition of portable pick-up equipment for live-talent programs. Although the equipment is intended primarily for field use, its flexibility is such that it can also be used as studio video equipment. Thus you can increase the diversity of your programs by having remote pick-ups one night, studio shows the next.

7 Equipment Layout for a Standard Television Station

This leaflet presents Stage 3—the addition of studio-type cameras and video equipment to provide a permanent studio system. This addition makes it possible to switch immediately from a remote pick-up to a studio show. Then too, this equipment is always available for rehearsal purposes.

8 Equipment Layout for a Master Television Station

Presents Stage 4—the addition of more studios and a master control room. Although Stage 3 will cover the needs of most stations for some time to come, Stage 4 will eventually be necessary for all major stations in large cities and for network stations that originate many studio programs.

Get your television station started now with this fully developed, in-production line of RCA equipment

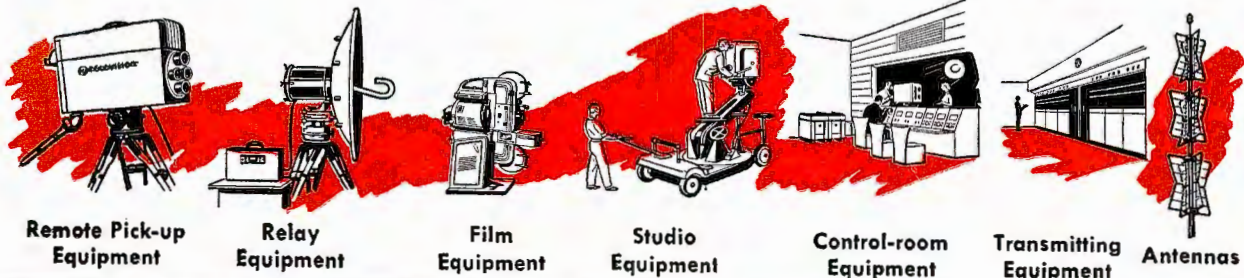

Remote Pick-up Equipment

Relay Equipment

Film Equipment

Studio Equipment

Control-room Equipment

Transmitting Equipment

Antennas

on practical, low-cost television-station planning

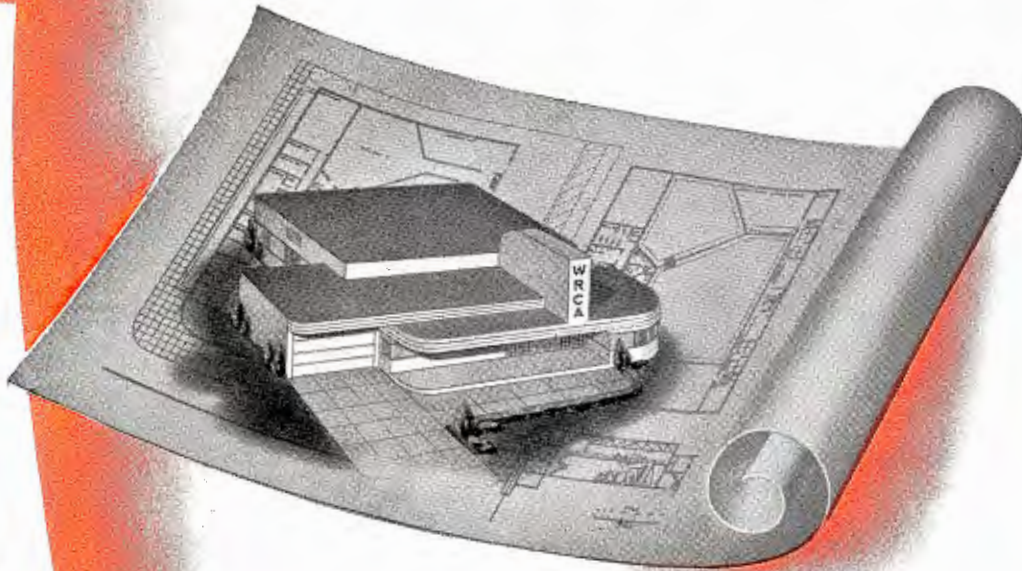

HERE'S a complete file of "how-to-go-about-it" information to help you get your television station started immediately. Many money-saving tips are given to keep your investment cost down—practical short cuts to get you on the air quickly.

The layouts and suggestions given are those that engineers, on the basis of their experience to date, believe they need. Stage-by-stage plans are given to permit easy station expansion as your television audience grows. Expansion can be carried on without making original equipment obsolete and with minimum interference to station operation.

The unique construction and programming problem of stations in small towns have been kept in mind, as well as the requirements of large cities. The emphasis throughout is on "down-to-earth" economy; there are no "blue-sky," costly plans.

Any one or all of these booklets are yours for the asking. You will find them an excellent construction check list from which individual adaptations can be made. Just let us know on your company letterhead which bulletins you need. Write Dept. 53-H, Television Equipment Section, Radio Corporation of America, Camden, N. J.



TELEVISION BROADCAST EQUIPMENT
RADIO CORPORATION of AMERICA
ENGINEERING PRODUCTS DEPARTMENT, CAMDEN, N.J.

In Canada: RCA VICTOR Company Limited, Montreal



The **TK-30A CAMERA**

with the **IMAGE ORTHICON**

by **NORMAN S. BEAN**
Engineering Products Department

First postwar television camera to make its appearance in quantities is the RCA Type TK-30A Field Camera. This camera, which uses the RCA-developed Image Orthicon, is now in quantity production. The first two units were delivered to NBC in June (these were two of the five cameras which NBC used in televising the Louis-Conn fight) and additional units have since been delivered to other customers. The TK-30A incorporates numerous improvements in circuit and design which grew out of RCA wartime experience in building more than 4,000 television cameras for the Army and Navy (the last 250 of which were designed to use the Image Orthicon tube).

Perhaps the most noticeable improvement in picture quality with this new camera is in the shadow detail which is obtained. Before the TK-30A Camera was used at Madison Square Garden it was impossible to recognize, or even see, the spectators sitting in the dim shadows beyond the ring. Spectators now have to be careful about whom they take to see the boxing matches.

The importance of good shadow detail will be appreciated by viewers of football games, who are accustomed to seeing fullbacks mysteriously disappear in the shadow cast by the stadium. During tests the new cameras have been tilted skyward to capture pictures of passing airplanes and blimps and then, without time for readjustment of controls, tilted downward into the shadows to catch an unscheduled contest between spectators.

Another important advantage is in the greatly increased depth of focus. Cameras of prewar design required lenses of twice the focal length for the same field of view. Furthermore, these long lenses had to be

operated at large apertures. At Madison Square Garden this reduced the depth of focus to less than the depth of the ring. Now everything in the ring and several rows of seats beyond are in focus.

These advantages stem from the amazing light sensitivity and small physical diameter of the 2P23 Image Orthicon Tube. The sensitivity of the Image Orthicon is so great that operation is possible with light levels as low as one-foot candle with an F3.5 lens. This makes the Type

TK-30A camera especially suitable for use where the lighting conditions are quite poor, as is frequently the case at sporting events, in night clubs, and at other remote pickup points. The possibility of picking up such events (without elaborate special lighting installations) has opened up a whole new vista in television programming. Cloudy weather and even rain are no longer a handicap. Baseball played under artificial illumination is a pleasure to watch. The last quarter of a November football game will no longer be a mystery.



(Left) Side view of the RCA Type TK-30A Field Camera which uses the Image Orthicon tube.

(Right) Rear view of the TK-30A Camera showing viewing hood and operating controls.



LENS TURRET is a feature of the TK-30A Television Camera. For ordinary operation four Eastman-Ektar lenses are mounted as shown. The top lens is in the operating position; any of the other three may be quickly brought into place by rotating the turret. If desired, a small projector may be substituted for one of the lenses. The projector will contain a 36-frame loop for 16 mm still pictures. Station call letters, advertising slogans, test patterns, and program titles can be shown without the necessity for switching back to the main station.

The lens turret is rotated by turning the handle located on the rear of the camera just below the view finder. A trigger switch incorporated in this handle cuts off the picture during the interval while the turret is turning. Changing from one lens to another (and refocusing) requires only one-and-a-half seconds by actual test.

Focusing can be accomplished in two ways. The main focusing control on the side door moves the Image Orthicon, its yoke, focus and alignment coils and mu-metal shield by means of a self-locking screw. In addition the Ektar lenses can be prefocused independently by turning their barrels. It is thus possible to focus the 50 mm lens on the announcer only three or four feet from the camera, focus the 90 mm lens on the infield, focus the 135 mm lens on the outfield and a telephoto lens on the scoreboard.

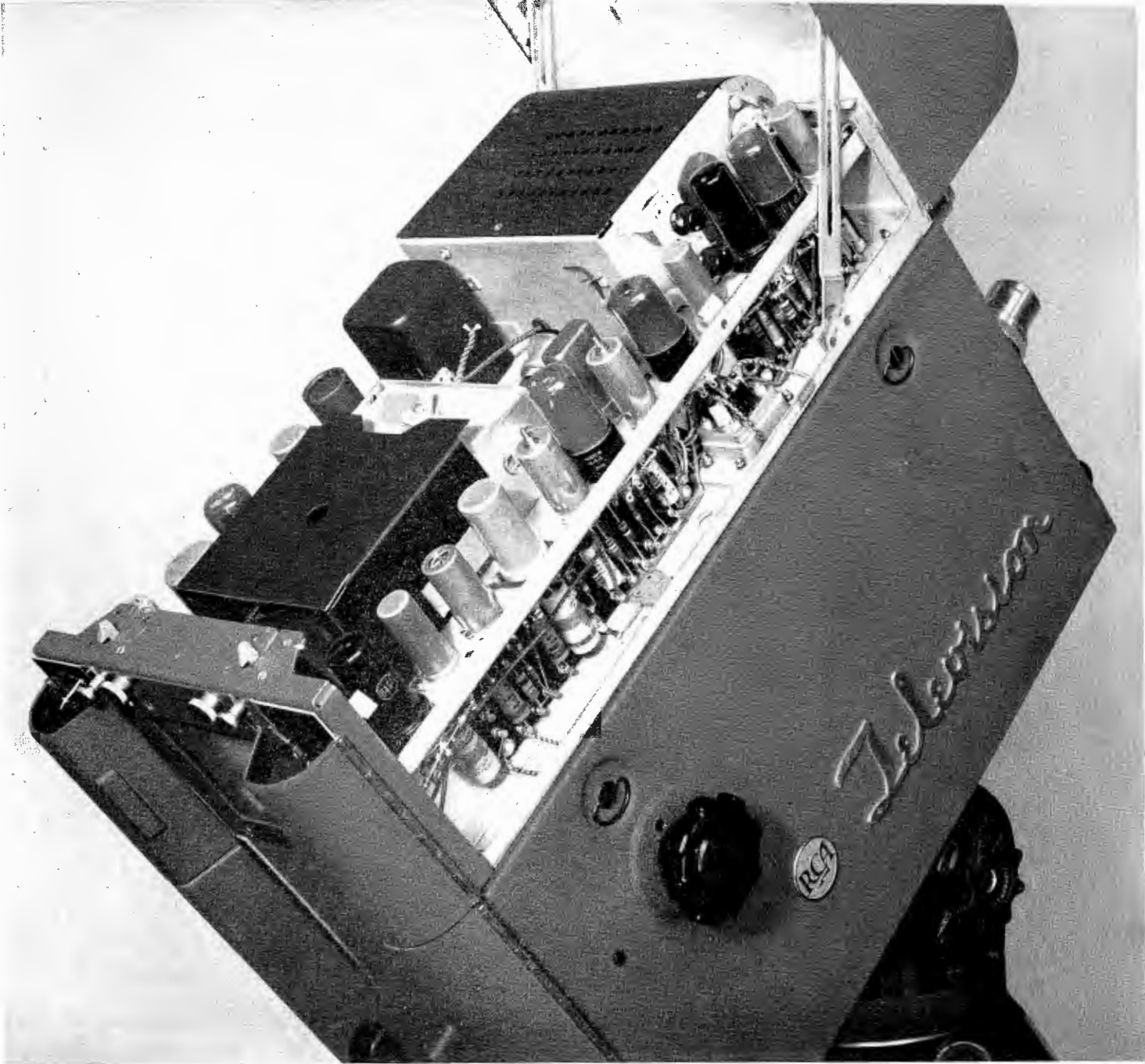

ELECTRONIC VIEWFINDER—The operator focuses the picture in the TK-30A Camera by observing the image on the electronic viewfinder. The use of the electronic viewfinder with this camera is a necessity since at low light levels an optical viewfinder would not be satisfactory.

The view above shows the top of the camera case raised to expose the interior of the electronic viewfinder which constitutes the upper section of the camera assembly. The viewfinder employs a 5-inch Kinescope with sufficient 2nd anode voltage to produce a satisfactory picture under normal outdoor light conditions. Since the operator sees on the face of this Kinescope the picture which is being transmitted to the camera control equipment, he is able not only to accurately focus the picture, but also to monitor the quality and general operation.

Two different viewing hoods are furnished with the TK-30A Camera. One is the straight-on type shown in the view on Page 6. The other viewfinder is a periscope-type viewer which has mounted in it two 45° mirrors. This periscope viewer may be mounted in a downward position, as shown in the picture at the right, or it may be mounted in an upward position as shown in the illustration on the following page. The viewfinders snap on and may be quickly interchanged.



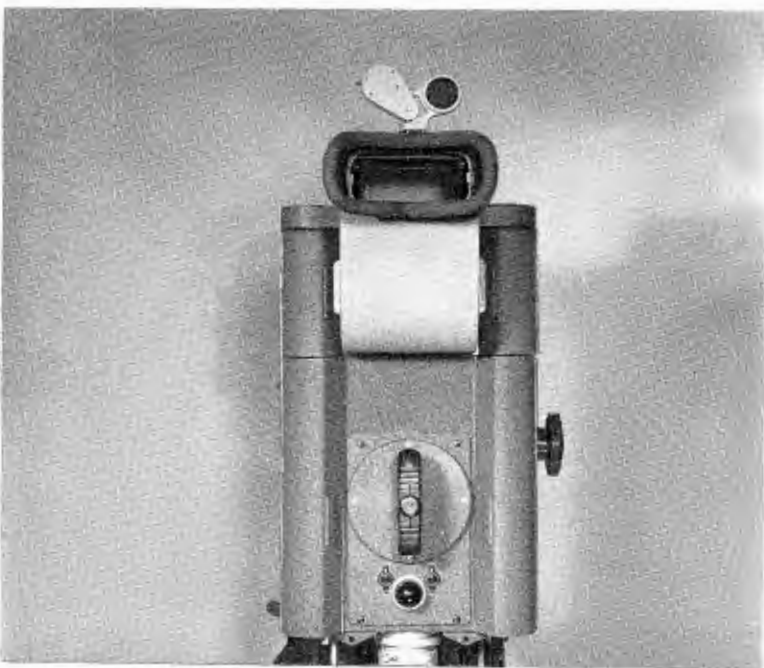
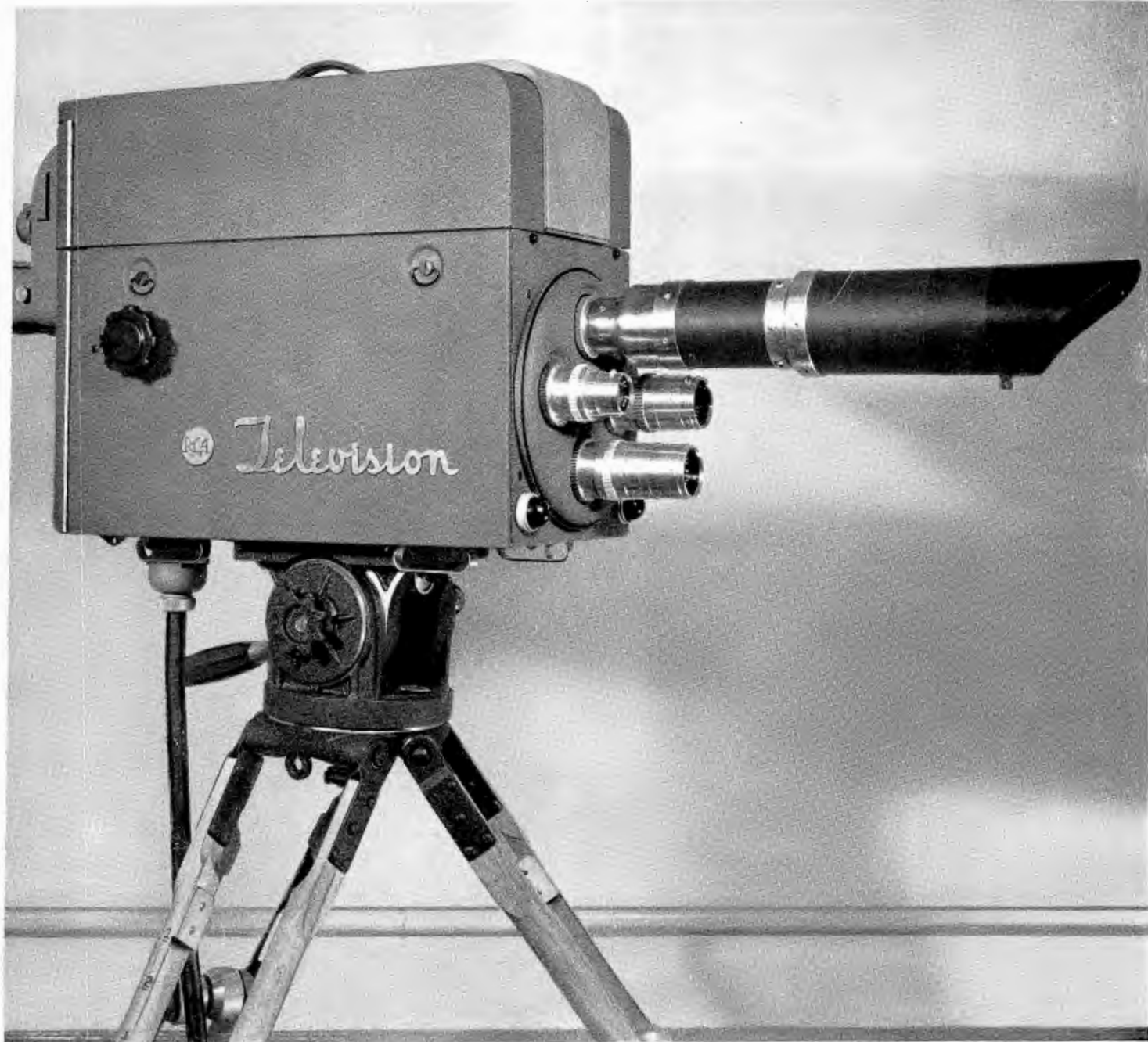

TELESCOPIC LENS: When the camera must be located at a considerable distance from the action, a telescopic lens may be substituted as shown in this view. Because the plate of the Image Orthicon is much smaller than that of previously used pickup tubes the focal length of the lenses required is only about half as great. This makes it possible to use relatively inexpensive standard lenses for all types of pickup.

Locating an outfielder with a long narrow-angle lens is facilitated by use of a polaroid gunsight (shown mounted above the viewfinder periscope hood in the illustration at the left). Several concentric rings appear through the gunsight to be in space superimposed on the "target." The field of view of the smallest ring is approximately that of a seventeen-inch lens. With this gunsight, it is possible to see outside the field of view. Therefore, it is easy to see where the outfielder throws the ball and quickly pan to the new center of action.

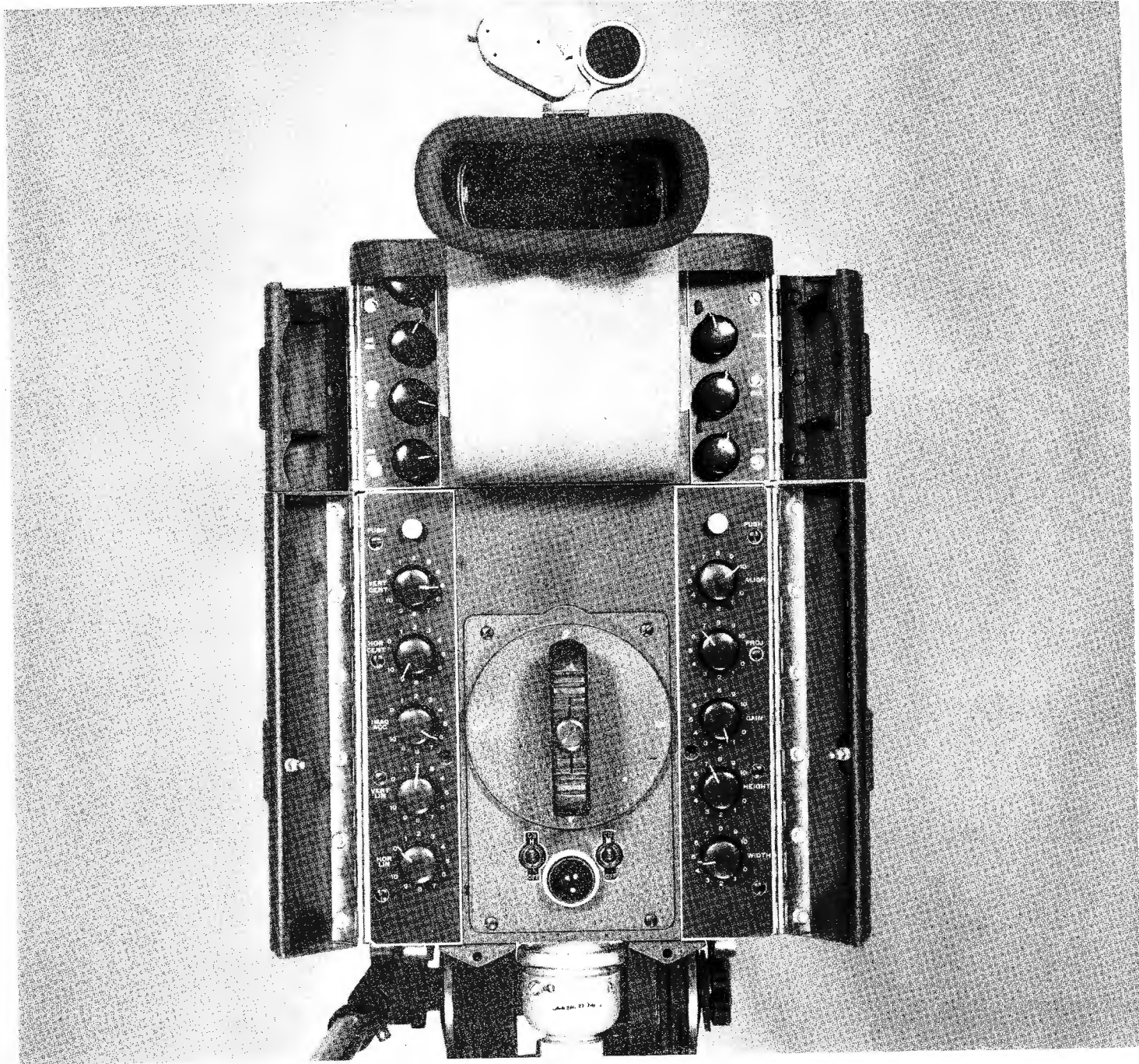

CONTROL PANEL. Shown above is the rear view of the TK-30A Camera with the control doors open to show the position of the controls used in making initial adjustments. On the lower panel are included controls for adjusting centering, linearity, gain, height, and picture width. These adjustments are for the transmitted picture. On the upper panel are similar controls for the picture which appears on the viewfinder. All of these are controls which are used only during initial setup. Controls requiring adjustment during operation are remotely located on the camera control unit. Thus the operator needs only to keep the camera directed on the scene of action and the picture correctly focused.

The TK-30A Camera has been carefully designed to provide quick access to all tubes, components and wiring. The view at the right shows the camera with the viewfinder case and the camera side door open. The hinged side of the camera case can be held in the horizontal position as shown, or opened all the way to provide more working room.

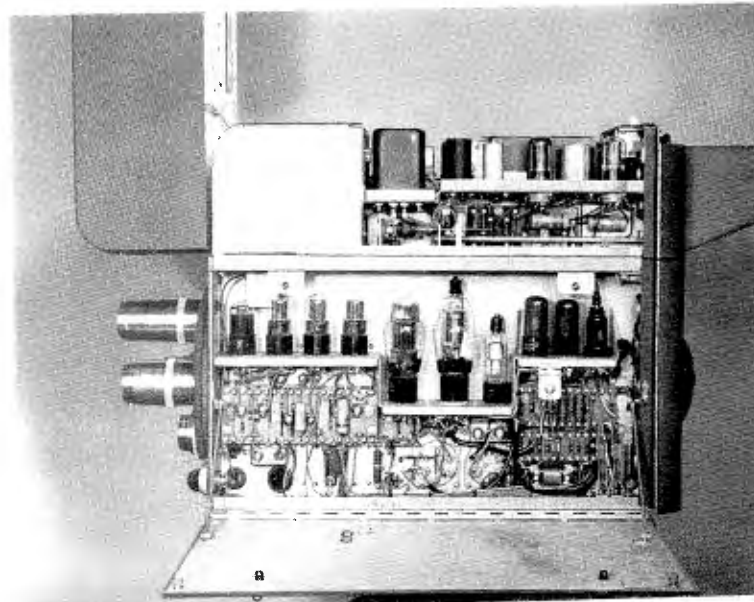

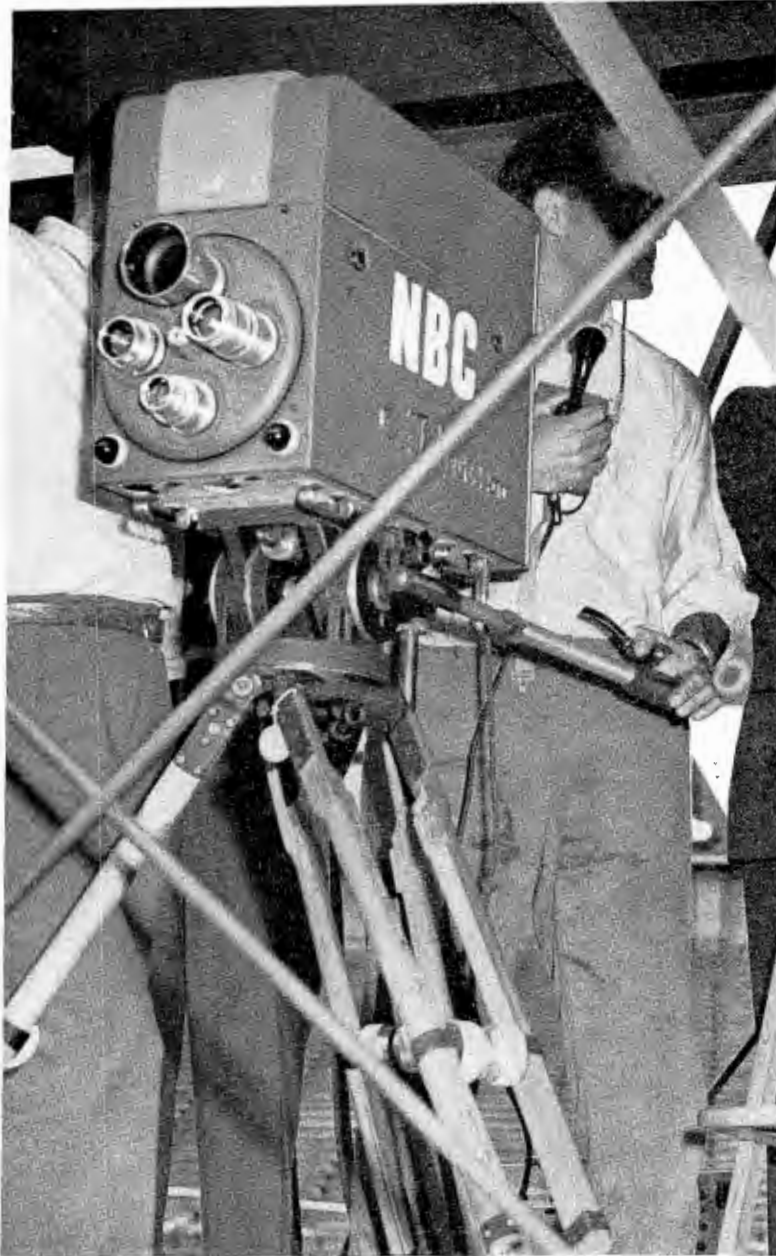

IDEAL FOR FIELD USE, the RCA Type TK-30A Television Field Camera is shown at the left as set up for operation (at the Louis-Conn fight). The complete equipment (which breaks down into several parts for easy carrying) weighs approximately 100 pounds, excluding the tripod. The camera is connected to the camera control equipment by a single cable which is less than one inch in diameter. This cable, which contains three coaxial lines and twenty-one wires, carries the video signal, power supply, synchronizing, monitoring, and inter-communication circuits.

EASILY TRANSPORTED—The TK-30A Camera is built in two main parts (the viewfinder and the camera proper). These sections plug together, and are held in place by an easily-released mechanism. The viewfinder, which weighs 35 pounds, and the camera, which weighs 65 pounds, can be carried short distances by one man. To make handling easier and protect the camera during transit, the camera section is provided with a separate cover (with carrying handles), as shown at the right. Where the space or requirements justify, the camera may be used without the viewfinder (the operator focusing by directions received from the monitor control operator).





NEED NOT BE CLOSE TO ACTION—Because of the telescopic lens feature, the TK-30A can be located some distance from the scene of action and still present “close-up” shots. Illustration at the left shows NBC cameras located 135 feet from the ring during the Louis-Conn fight broadcast. (Cameras are in the lower section of platform at the right.)

CAN BE USED IN THE STUDIO—While the TK-30A Camera was especially designed for field use, it is believed that it will also be satisfactory for most types of studio programs. For such use the tripod may be mounted on a dolly (as shown at right) so that it can be moved around more easily. Or it may be removed from the tripod and mounted on a more elaborate type of pedestal.





INFRARED FLYING HELMET—For night flying provided the best means of identifying and following enemy planes at close range.

RCA WAR RESEARCH - WHAT IT MEANS TO YOU

by **LOREN F. JONES**

Manager, Research and Development Section
Engineering Products Department

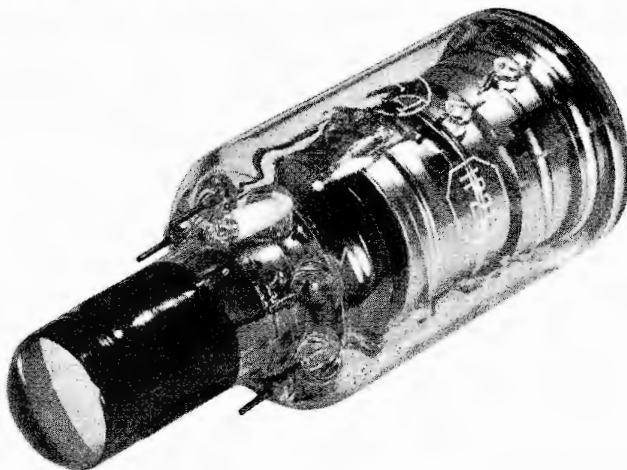

FIG. 1. IMAGE TUBE—This is the RCA 1P25 image tube used in infrared viewing devices. The image tube, an RCA development, transforms an invisible (infrared) scene focused on the large end of the tube into a visible picture on the small end.

The social, political and economic impact of war research is so great that every man's future is changed. The atomic bomb is only the most dramatic of the developments so far revealed. There are others which may have an equal effect on our peacetime living. Scientists truly stand in awe before their own works.

Although it is presently impossible to evaluate the broadest implications of war research, some of the more immediate technical results in specific fields can be easily discerned. In the case of RCA, which conducted war research and development on a very broad scale, it is not difficult to select numerous items of technical interest to broadcast engineers. Unfortunately, many subjects cannot be mentioned because they remain confidential or secret.

FIG. 2. INFRARED TELESCOPE—This instrument, using a very sensitive image tube in conjunction with an infrared searchlight, is able to pick up (in total darkness) a shoreline a mile away or identify trucks and tanks at 700 feet. The infrared devices shown on this page are only a few of the numerous types developed by RCA engineers.



INFRARED

In the field of imaging by means of "near" infrared light, RCA has been far more active than has been anyone else in the U. S. A. The image tube, an RCA development, is the device which transforms invisible images into visible ones. Infrared can be used for signaling and for seeing without visible light. All electronic infrared image devices used by the Army and Navy were developed by RCA. Thousands were produced by RCA, with less quantities of similar designs produced by others.

Possibly the most interesting infrared device was the sniper-scope developed for the Army. A soldier carrying this carbine rifle, equipped with an infrared spotlight and image tube telescope, could see, identify the uniform, and kill a man at 150 feet, all in total darkness. This one weapon alone accounted for more than 30% of the Japanese killed by ground action on Okinawa.

Another application of infrared was in driving vehicles at night without visible lights. Tests showed that it was possible for drivers to follow roads while moving in absolute darkness. By using two image tubes to provide binocular vision, the driver of a scout car could operate it at 40 or 50 miles an hour.



FIG. 3. SNIPERSCOPE—An infrared spotlight and image tube sight mounted on a carbine made it possible for U. S. infantrymen to identify and kill an enemy at 150 feet in total darkness. This weapon alone accounted for 30% of Jap casualties on Okinawa. This is the prototype which was developed by RCA.

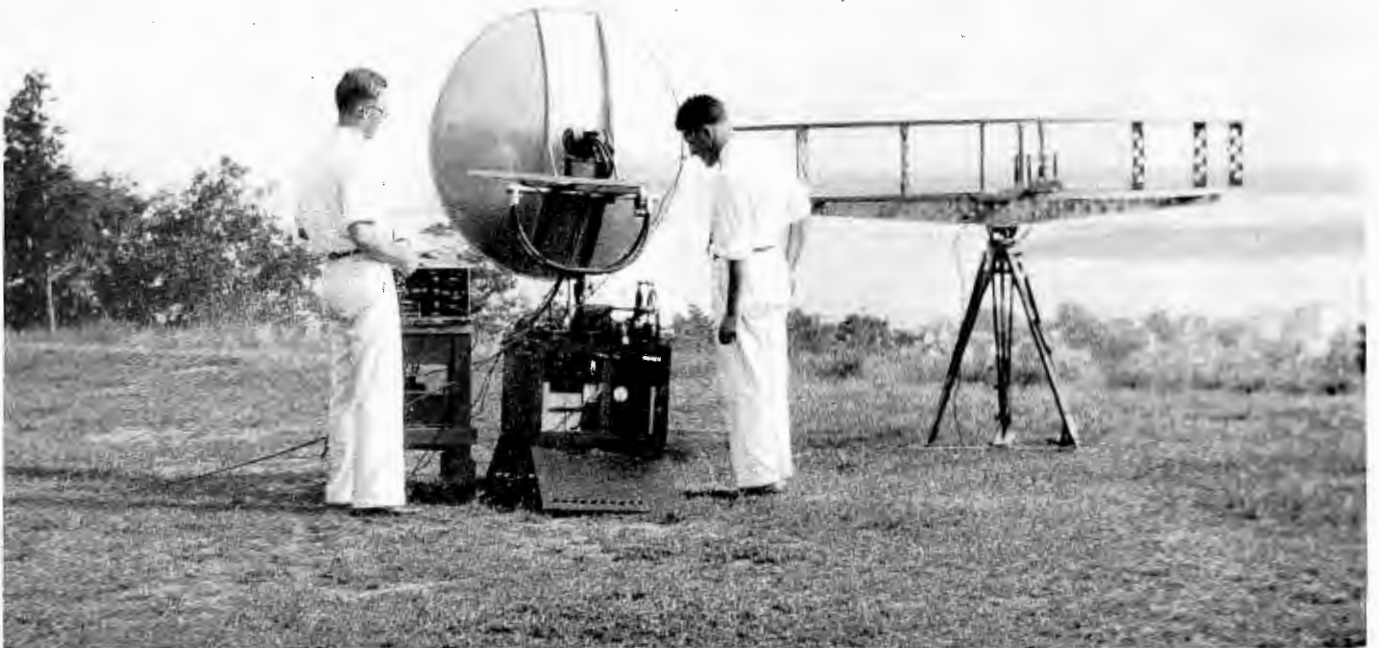

FIG. 4. RCA engineers pioneered in the development of microwave equipment for radar and communications purposes. The illustration above shows Dr. E. G. Linder and Dr. Irving Wolfe, of RCA Laboratories, with a voice-modulated 9 cm. transmitter set up at Navisink Light in the summer of 1934. The equipment to the right is a Signal Corps 60 cm. transmitter



FIG. 5. This view shows the 9 cm. receiver (used with the transmitter shown above) installed on an army boat in New York harbor.



FIG. 6. This view shows Dr. Linder with a 9 cm. pulse transmitter located on the roof of an RCA building in Camden in 1936.

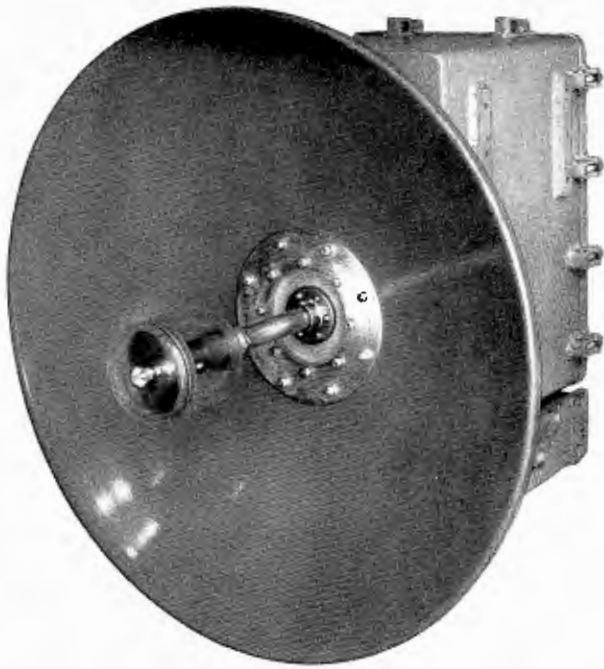

FIG. 7. This is an RCA-developed X-band radar designed for fire-control use.

The reconnaissance possibilities of the image tube in combination with an infrared searchlight were recognized early in the development work. Eventually tubes of such sensitivity were developed that they permitted seeing a shoreline a mile away and seeing trucks, tanks and other large vehicles at 700 yards.

Peacetime applications of infrared image tubes may include certain forms of night time police surveillance. Another application may be the observation of industrial operations which must be carried on in full darkness, such as the manufacture of the most sensitive photographic film.

To the broadcast engineer, the development of the image tube was important because it resulted in techniques directly applicable to television pickup tubes, giving them useful infra-red sensitivity and improved photoemissive properties.

RADAR

RCA's research and development on radar started in 1935 and expanded to a scope far too broad to describe here. The first airborne radar on record was developed by RCA. The first microwave radar was developed jointly by RCA and the Signal Corps. Every type of radar altimeter used by the Army, Navy, or British was developed by RCA, and 30,000 were produced by RCA. Some of these altimeters were of the pulsed radar type, others of the FM radar type.

The phenomenally accurate radar bombing system known as Shoran—officially said by AAF to be the most accurate of any—was 100% developed and produced by RCA.

"Tailwarning" equipment, which warned fighter pilots of the presence of enemy aircraft, saved many lives. It was developed exclusively by RCA. . . . And so the story goes.

What do these radar developments mean to the broadcast engineer? For one thing, they mean better and cheaper cathode ray tubes for television. In producing more cathode ray tubes

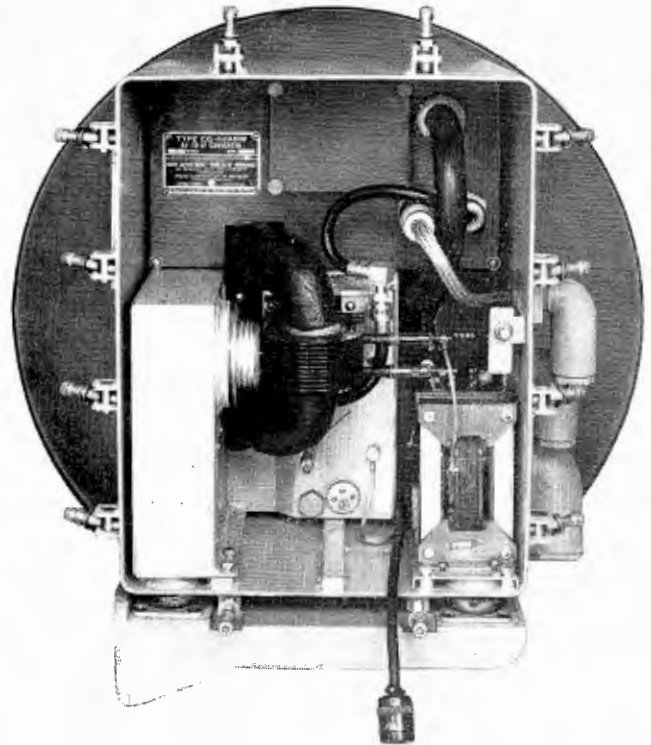

FIG. 8. Rear view of the radar equipment shown at left. Note magnetron tube in center.

than did anyone else, RCA learned to take many dollars out of television receiver costs, not to mention economies in cathode ray oscillographs and other cathode ray equipment. For another thing, high frequency receiving and transmitting tubes were developed, and these very tubes or modifications of them will assist in experimental television applications on the high frequencies. Newly developed radar tubes, antennas and waveguides permit designing studio-transmitter links for microwave operation employing very sharp beams. The television relay link already announced by RCA is based on many radar developments.

In developing and producing equipment for projecting the images from radarscopes onto large screens, knowledge was gained which will further the projection of television in the theatre and home. Incidentally, RCA is still the only firm which has produced the optically precise metal molds needed for making aspherical plastic lenses used in television projection. Lenses have recently been provided to approximately 50 broadcast receiver manufacturers to aid them in their development of television receivers.

PROXIMITY FUSE

In producing 5,500,000 proximity fuses—the fantastic 5-tube radios which operated after being shot out of a gun—RCA accounted for more than half of the total U. S. A. production. It isn't easy to make a radio set which stands an acceleration of 20,000 g (zero to 2,000 miles per hour in 10 feet) and which, after that, operates while merrily spinning at 10,000 rpm.

The proximity fuze development was useful to the broadcast engineer because it produced techniques for "ruggedizing" and for reducing radically the size of tubes, components, and assemblies, with resulting eventual benefit to all types of portable radio equipment. Manufacturing facilities were set up for the quantity production of high quality precision equipment.

STUDIES

Formal and extensive studies were undertaken under contract. Some pertained to systems problems and required the kind of "systems thinking" for which few firms are qualified. Others covered propagation effects, antenna patterns, modulation comparisons, and pilotless aircraft projects.

To the broadcast engineer, the more than 40,000 man hours devoted to such studies is significant because it brought forth new technical information and conclusions and it taught many engineers to plan and think in terms of systems rather than individual gadgets.



FIG. 9. 500,000 WATTS—That's what the RCA Type A-2231 Pulse Triodes put out (pulsed service) at 600 mc! This tube, shown above, was developed for high-power radar applications.

FIRE CONTROL AND COMPUTERS

In working on anti-aircraft fire control and on several pilotless aircraft projects, RCA developed in its Princeton Laboratories a new type of an electronic computer which has phenomenal accuracy and speed. Details cannot be published, but some of the new techniques of this computer can and will be used for non-military purposes.

To the broadcast engineer, the techniques will prove useful when they are incorporated in computers for general scientific purposes. Bi-products of computer research are likely to prove highly valuable. The most direct application of RCA's computer techniques will be in directing the flight of guided missiles, particularly jet propelled and rocket types which fly so fast that they cannot be controlled by human beings. For such missiles, the reaction time of the human being is far too slow, as are mechanical types of computers, with the result that the electronic type as developed by RCA must be used.

TELEVISION

Approximately 90% of the television development and production sponsored by Army, Navy and OSRD was conducted by RCA. Over 4,000 television cameras were produced! Types of equipment developed include ground, shipboard, and airborne television cameras, transmitters and receivers. Even underwater tests were conducted. The airborne transmitters ranged from 10 to 1500 watts. Telemetering equipment used television to transmit instrument readings from pilotless aircraft to operators on the ground, thus allowing the operator to fly the aircraft to destruction without personal risk and with a complete knowledge of the readings of all instruments in the aircraft. Very compact pickup and monitoring equipment, joined by coaxial cable rather than by radio circuit, was developed and used for trans-

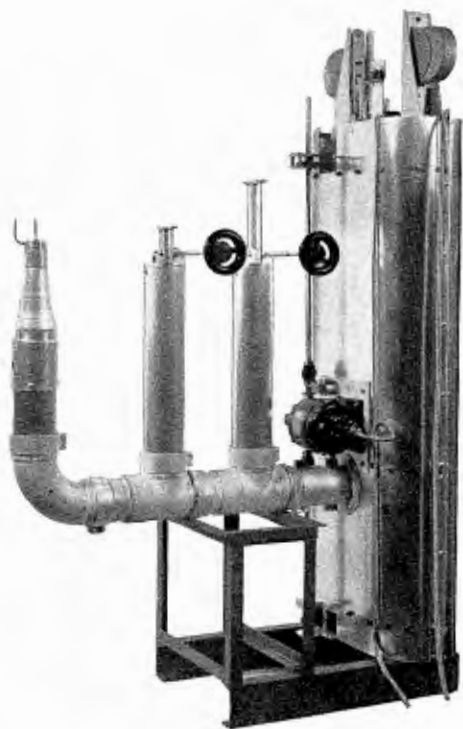

FIG. 10. MILLION WATT OSCILLATOR—This is an external view of an oscillator which uses two A-2231's to provide an output of 1,000,000 watts duty cycle 0.1 per cent at 600 megacycles. Note directional antenna on the end of the transmission line.



FIG. 11. TANK CIRCUIT—This is an interior view of the one million watt oscillator. The two A-2231 tubes are mounted at the ends of the large "hairpin" in the center. This circuit actually tunes from 560 to 640 megacycles.

mitting visual information from point to point. Some of these equipments were used in manufacturing explosives where it was desired to place a television camera at a point dangerous for human beings. Others were used in the recent "Operation Crossroads" tests. One of the most important wartime developments was the supersensitive image orthicon, which was described in the last issue of BROADCAST NEWS.

The importance of the image orthicon pickup tube to the broadcast engineer is obvious. The compactness of some of the wartime television equipment, particularly the airborne apparatus installed in glide bombs, already has materially contributed to compactness in field pickup equipment for broadcasters. And not least of the benefits of wartime television work will be the experience gained in picking up scenes from the air. Such pickups may constitute an important feature in future television programs. RCA's experience in flying many kinds of television in many kinds of aircraft will not only result in better equipment, but will help those responsible for television programming. So compact is one of the equipments that the combined weight of camera, amplifier, synchronizing circuits and transmitter is 50 pounds. The next step beyond this equipment will indeed bring us close to General Sarnoff's oft predicted "walkie-lookie."

THINGS TO COME

RCA will continue to take a very active part in research and development activities pertaining to national defense. Already new laboratory space is being acquired to accommodate some of this work. Our country needs the services of the largest and best scientific and engineering organizations.

As is always the case with research, the results to be obtained cannot be predicted in advance. New tubes, new frequencies in the millimeter region, "walkie-lookie" television cameras, and many other innovations will appear. Certainly, as in the past, the achievements of future research will be of great significance and will benefit not only the Army and Navy, but the broadcast engineer, the physician, the housewife—in fact, all elements of the public.

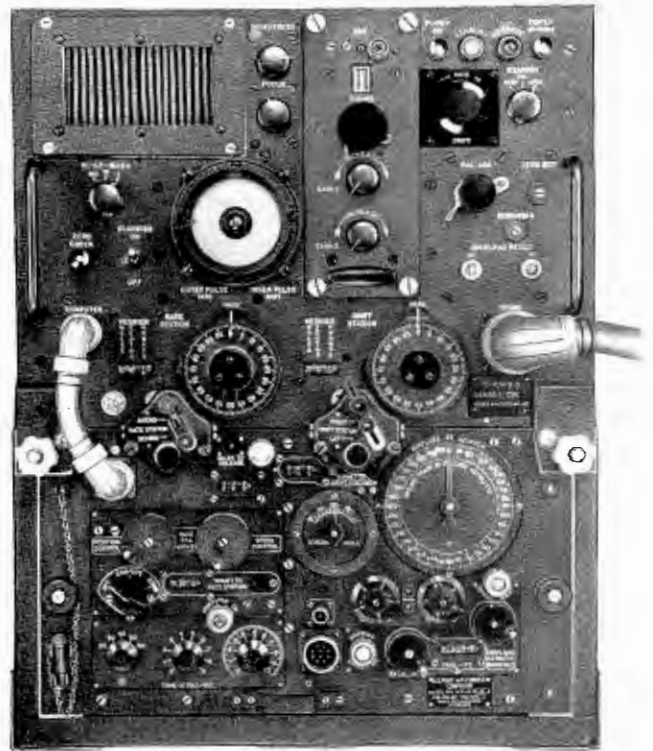

FIG. 12. SHORAN—This is the airborne part of the fantastically accurate bombing equipment known as SHORAN. Developed by RCA, this system has been described by the AAF as the most accurate of all bombing methods. It is now being used by map makers, oil geologists and others as a precision surveying instrument.



FIG. 13. SHORAN BOMBING—Photo at left shows cluster of bursts from bombs dropped by SHORAN direction on a railroad bridge in Italy. Earlier visual bombing (note old bomb pocks) had failed to destroy this bridge. SHORAN bombing cut four spans as evidenced by photo at right (note lack of shadows for these spans).

MICROWAVE for TELEVISION

by **W. J. POCH**
and **J. P. TAYLOR**
Engineering Products Department



FIG. 1. This is the complete microwave transmitting equipment. It consists of the parabolic antenna, the transmitter proper, (in the case attached to the rear of the parabola), and the transmitter control unit. This antenna has a power "gain" of 5000 (which gives an "equivalent power" of 500 watts with a transmitter output of only 100 milliwatts).

RCA now has in quantity production television relay equipment designed for operation in the microwave bands. This equipment which was developed by D. A. Rosencrans and A. H. Turner, engineers in the Television Terminal Equipment Section directed by M. A. Trainer, includes transmitters, transmitter control units, antennas, receivers, and receiver control units—i.e., all of the units required for a complete point-to-point installation. The first set of this equipment has been delivered (to NBC) and is in operation. Additional equipments are nearing completion, and it is expected that by late fall production will be sufficient to meet the requirements of the television stations under construction or in operation at that time.

Radio link circuits for television are, of course, not news in themselves. They have been the subject of speculation and experimentation since RCA first demonstrated this application (in a circuit from Long Island to New York) in 1936. In recent years there have been a number of one-of-a-kind installations which have been in more or less regular use for television relaying. However, the equipment shown on these pages differs from all such previous equipments in three important respects, which are:

- (1) It uses war-developed reflex Klystron circuits in both transmitter and receiver. This makes possible an equipment which is small in size, and relatively light, so that it is suitable for mobile as well as fixed use.
- (2) It operates on much higher frequencies (6800-7050 mc) than have previously been used for this service, thereby making possible high-gain antennas which provide much better signal-to-noise ratios.
- (3) It is not experimental, not a one-of-a-kind made for the manufacturer's own use, but rather a production design of which the units shown here are the first from a factory assembly line set up to manufacture identical units in quantity.

NEED FOR RADIO LINKS

Because of the 4.5 mc bandwidth required for transmitting video signals, the telephone lines presently used for broadcast-

EQUIPMENT RELAY SERVICE

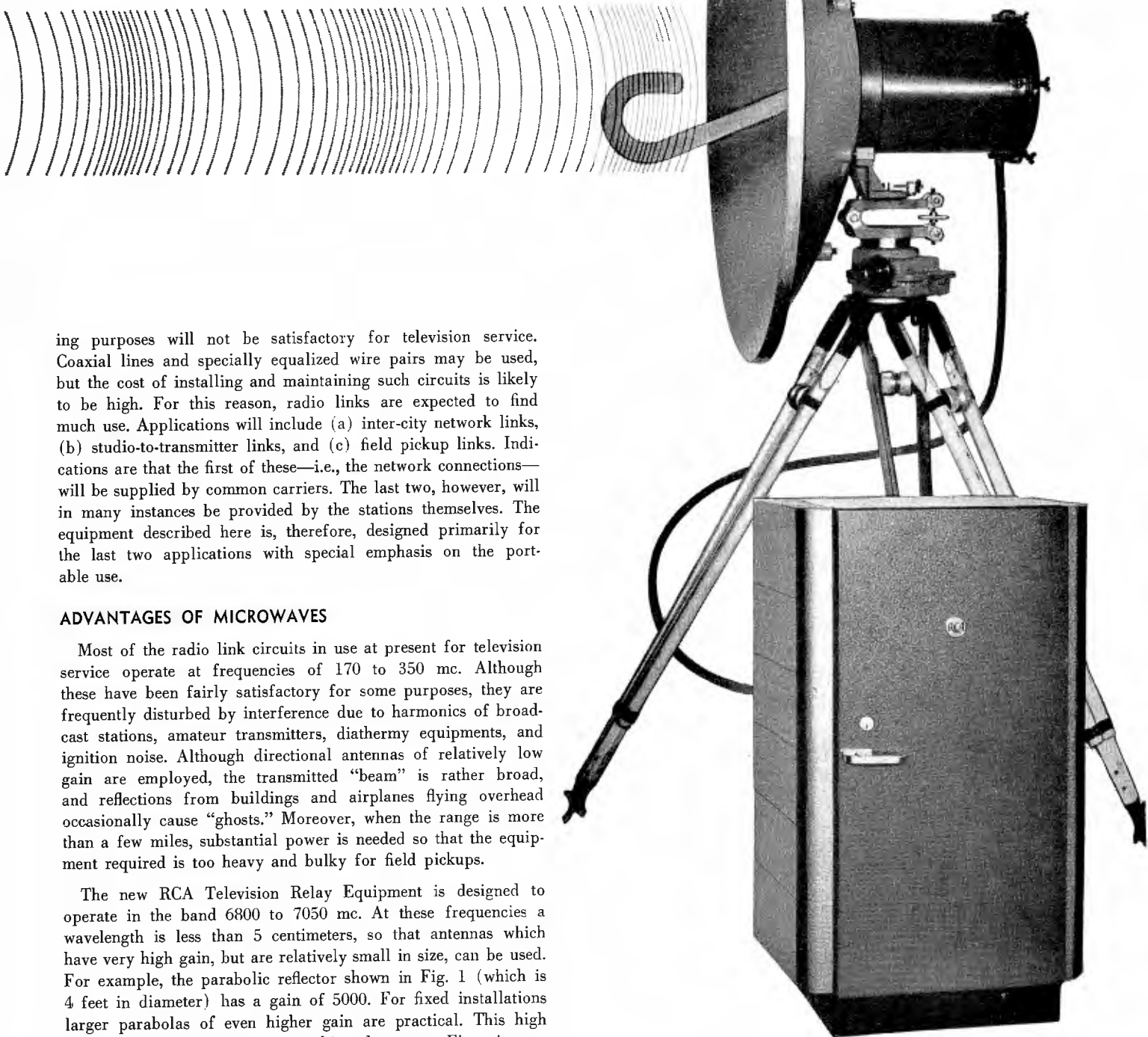

ing purposes will not be satisfactory for television service. Coaxial lines and specially equalized wire pairs may be used, but the cost of installing and maintaining such circuits is likely to be high. For this reason, radio links are expected to find much use. Applications will include (a) inter-city network links, (b) studio-to-transmitter links, and (c) field pickup links. Indications are that the first of these—i.e., the network connections—will be supplied by common carriers. The last two, however, will in many instances be provided by the stations themselves. The equipment described here is, therefore, designed primarily for the last two applications with special emphasis on the portable use.

ADVANTAGES OF MICROWAVES

Most of the radio link circuits in use at present for television service operate at frequencies of 170 to 350 mc. Although these have been fairly satisfactory for some purposes, they are frequently disturbed by interference due to harmonics of broadcast stations, amateur transmitters, diathermy equipments, and ignition noise. Although directional antennas of relatively low gain are employed, the transmitted "beam" is rather broad, and reflections from buildings and airplanes flying overhead occasionally cause "ghosts." Moreover, when the range is more than a few miles, substantial power is needed so that the equipment required is too heavy and bulky for field pickups.

The new RCA Television Relay Equipment is designed to operate in the band 6800 to 7050 mc. At these frequencies a wavelength is less than 5 centimeters, so that antennas which have very high gain, but are relatively small in size, can be used. For example, the parabolic reflector shown in Fig. 1 (which is 4 feet in diameter) has a gain of 5000. For fixed installations larger parabolas of even higher gain are practical. This high gain provides not one, but two big advantages. First, it provides a relatively high "equivalent power" with a very low transmitter power. For example: by using the 4-foot parabola, shown in Fig. 1, and a transmitter power of only 100 milliwatts, an equivalent power of 500 watts is obtained. This makes possible very simple small-sized, light-weight transmitter units. A second,

FIG. 2. This is the microwave receiving equipment. It consists of a parabolic antenna (identical to that at the transmitter), the receiver pre-amplifier, (in the cylindrical case attached to the rear of the parabola), the receiver control unit, and a power supply unit. The last two are mounted in the cabinet at the bottom. The control unit in a portable case is shown in Fig. 17.



FIG. 3. Where used for remote pickup (at football games, prizefights, etc.) the antenna, parabolic reflector, and attached transmitter will usually be placed in a temporary position on the roof of the stadium or other high point. The transmitter control unit may be mounted in a more convenient position (for instance, with the camera control units) and may be as much as 400 feet away.

and equally important advantage is that transmitted power is concentrated in a very narrow beam. The receiver, which uses a similar antenna, has a very narrow angle of pickup. When the two antennas are lined up on each other, an exceedingly selective path is provided. This has the effect of eliminating all extraneous reflections, whether from fixed or moving objects. The narrow reception angle, together with the negligible interference at these extremely high frequencies, provides almost noise-free transmission over line-of-sight paths up to 15 miles or more. There are other advantages to the use of microwaves, such as the availability of many channels, the ease with which wideband modulation may be obtained, and the fact that numerous links may be operated in the same area without interference.

TESTS OF THE SYSTEM

Although the advantages of a microwave system seemed obvious, RCA engineers, nevertheless, did not go ahead with design of a commercial product until after exhaustive tests had been made. Starting about two years ago, several experimental models were built and field-tested. One of these was permanently installed as a link connecting a studio in the RCA plant in Camden with the transmitter control room of W3XEP (RCA's experimental television station) which is $1\frac{1}{2}$ miles away. In the 15 months this circuit has been in operation nearly 100 scheduled transmission tests have been carried. At no time has any trouble whatsoever been encountered from noise or interference, even though the main antenna of W3XEP is within 200 feet of the relay receiver.

A second set of equipment, very similar to the final design, has been in use for various purposes during the last nine months. It has been used on a number of occasions as a portable equipment to pick up programs for W3XEP at remote points in Camden. In such cases the video signal is sent back to the studio and from there to the transmitter by the studio-transmitter link mentioned above. This use of two of these equip-



FIG. 4. The transmitter proper is contained in this case. The short transmission line (wave guide in the center) eliminates line losses and impedance matching problems encountered when transmitter and antenna are located at separate points.



FIG. 5. For maintenance or replacement the transmitter chassis can be removed from the case by loosening three thumb nuts. No connections need be removed.

ments, in series so to speak, did not result in any degradation of the picture, showing that such multiple use is entirely practical. This equipment was also used during the demonstrations of RCA Color Television at Princeton last December and January (to transmit the video signal from the RCA Laboratories to the Princeton Inn). It was used with great success by NBC to transmit the proceedings of the UNO at Hunter College back to Radio City (a distance of 9 miles). It has been tested over a 23-mile path from Freeport, L. I., to Radio City. At this distance some noise is contributed by the relay link, but it was considered to be less than that contributed by the cameras themselves. On the basis of these tests, it appears that this equipment will be very satisfactory for line-of-sight distances up to 15 or 20 miles.

ARRANGEMENT OF EQUIPMENT UNITS

This equipment, as previously noted, was designed with an eye to the requirements of portable use. For this reason the several units of which it is composed have been made as light and as readily portable as possible. The general arrangement of the transmitter components is shown in Fig. 1. The antenna consists of a metal parabola (4-foot and 6-foot diameters are available) which focuses, into a narrow beam, the power which is fed to its focal point by a hook-shaped wave guide. This wave guide is simply a hollow metal pipe. The cross-section of this pipe, $1\frac{1}{2} \times \frac{3}{4}$ inches, is such as to provide optimum performance over the band of 6800 to 7050 mc.

The transmitter proper is enclosed in a cylindrical weather-proof housing which is rigidly attached to the back of the parabola. This arrangement makes possible a very short transmission line (wave guide) between transmitter and antenna and eliminates all of the matching and loss problems which are encountered when the transmitter and antenna are located at different points.

The combined transmitter-antenna assembly is provided with either of two types of mounting. One of these, shown in Fig. 1,

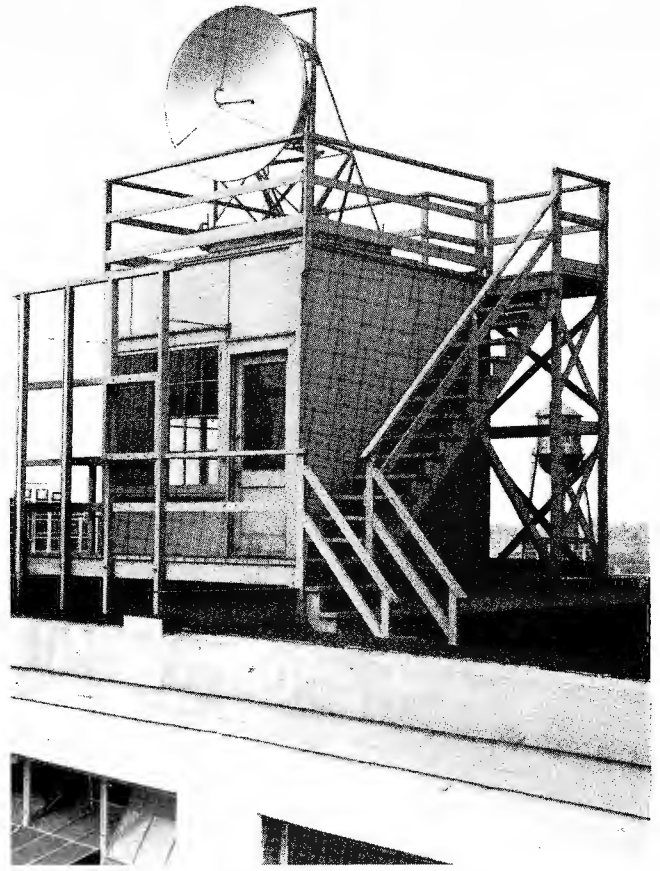

FIG. 6. The receiving antenna (and attached receiver preamplifier) will ordinarily be mounted on a high building near the main studio. This mounting may be temporary or permanent depending on the amount and type of usage. When the equipment is used for S-T-L service both transmitter and receiver may be provided with permanent types of mountings similar to the one shown above.

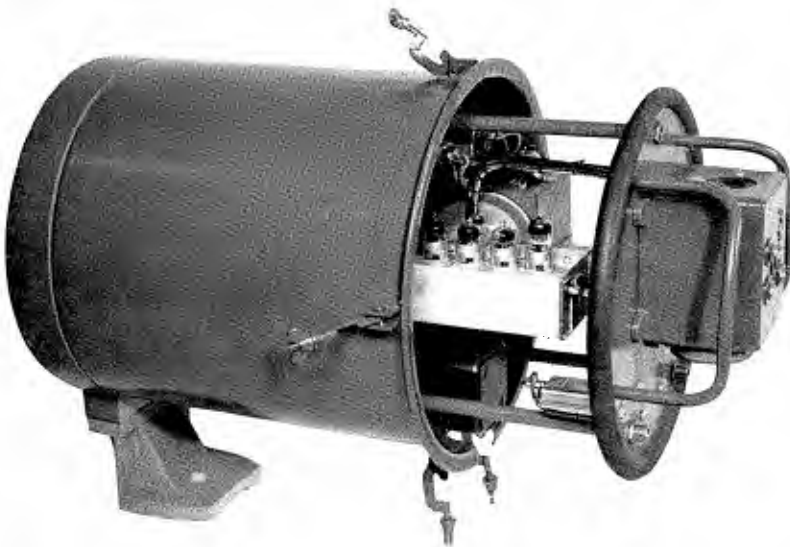

FIG. 7. Receiver chassis partly removed from the case. This demountable arrangement makes it possible to quickly substitute another chassis in case of failure.

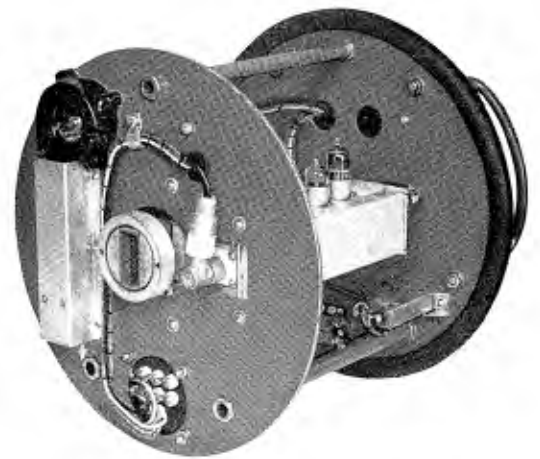

FIG. 8. This view of the parabola end of the receiver chassis shows the small blower which provides ventilation for the unit. A similar blower is mounted on the transmitter chassis.



FIG. 9. When the weather-proof back cover is removed, the cable connection (center) and metering jacks are accessible. Cable, which is similar to standard camera cables, allows transmitter control to be located 400 feet away.

is a rotatable type which allows the parabola to be moved through a wide angle in either the horizontal or vertical angles. Calibrated scales are provided so that the approximate direction can be set by compass. When the equipment is used in portable form for field pickups, the assembly may be mounted on a heavy tripod as shown here. For fixed use, a more permanent mounting is desirable. A second type of mounting, which provides for only small adjustments of horizontal and vertical directions, is available for this purpose.

The power supply for the transmitter and the operating controls are contained in a small suitcase-type unit which may be located as much as 400 feet from the transmitter-antenna unit. Connections between are made by a single cable, of the same type used between cameras and camera control units. Thus, for field use, the transmitter-antenna assembly can be placed on some high point, such as the top of a stadium, while the control unit is located at some more convenient point (as, for instance, with the camera control and switching units). For fixed use, the transmitter-antenna can be mounted on the top of the building (or a tall tower) with the control unit mounted on a rack in the studio control room.

The arrangement of the receiver components (Fig. 2) is similar to that of the transmitter. The antenna is identical except, of course, that in this case the parabolic reflector picks up the signal and the wave guide feeds it to the receiver unit mounted in the can attached to the rear of the parabola. This receiver unit includes only the heterodyne oscillator, first detector, and four i-f stages. Signal at i-f frequency is fed from this "pre-amplifier" to the remaining stages of the receiver which, along with the receiver operating controls, are located in a receiver control unit. This unit, like the transmitter control unit, is a separate unit which can be located as much as 200 feet away. The receiver control unit requires a separate power supply which is a similar sized unit. These units, like the transmitter control, are mounted on standard "bathtub" type chassis. Thus they can

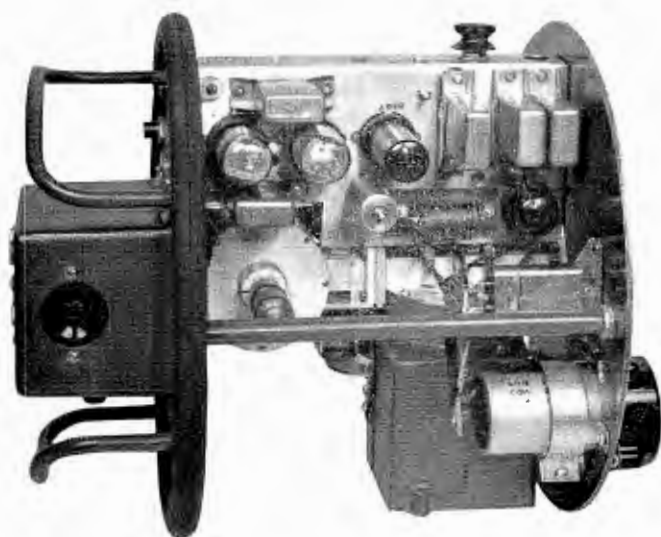

FIG. 10. This is the transmitter chassis after removal from the case. The Klystron oscillator is contained in the small square case at lower right. The wavemeter is enclosed in the round compartment on the end of the wave-guide.

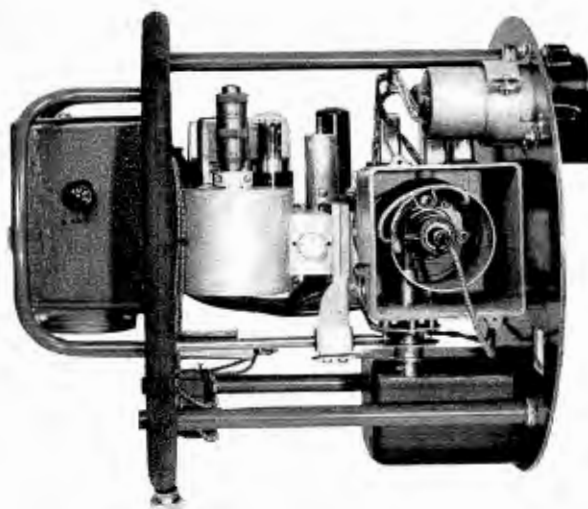

FIG. 11. This shows the oscillator compartment with the cover removed. This compartment is temperature-controlled for better stability. The Klystron oscillator is mounted so that its base projects into the wave guide.



FIG. 12. The transmitter control unit in the convenient carrying case. Both transmitting and receiving equipments are designed to be easily portable.



FIG. 13. Interior of the transmitter control unit. All components are mounted on a standard bathtub-type chassis, which can be mounted on a relay rack or in a suitcase-type carrying case as shown here.

be mounted in carrying cases of the type shown in Fig. 1, on standard equipment racks, or in a small cabinet rack as shown in Fig. 2. Since the receiver will ordinarily be used at a fixed point, the usual arrangement will be to have the receiver-antenna on a tower or other high point while the control and power units are mounted on racks in the studio or transmitter control room. However, in some cases, it may be necessary (in order to get a line-of-sight path) to use some intermediate receiving or relaying point in which case the portable arrangement may be used.

DESCRIPTION OF TRANSMITTER

The transmitter chassis, which is mounted in the cylindrical case (Fig. 4) attached to the parabola, contains the oscillator and modulator circuits, a monitor and a wave meter. When the lid of the weatherproof case is opened, the chassis connections are made accessible as shown in Fig. 9. These connections include the large cable from the transmitter control unit, a jack for interphones for communicating with the control point during set up, a jack for monitoring and another for metering. The latter are used only during test adjustments. There is also a convenient 110-volt outlet.

To provide for easy maintenance and replacement in emergency, the transmitter chassis is made demountable. When three thumbnuts are removed, the whole chassis can be slid out of the case as shown in Fig. 7. The chassis itself is shown in Fig. 10 and Fig. 11. Center of the chassis assembly is the wave guide which extends the length of the unit. The oscillator, a Type 2K26 Klystron, is mounted in the shielded compartment (at the right in Fig. 11) in such a position that its base extends into the wave guide. The oscillator compartment is temperature-controlled to improve the frequency stability. Tests indicate that after a warm-up period of 15 minutes, this oscillator will hold its "center" frequency within ± 2 mc for periods of an hour or more. Power output of the oscillator is approximately 100 milliwatts.

The oscillator is frequency modulated by varying the reflector voltage at video frequency. Normal deviation is approximately 8 mc with polarity such that video signal in the white direction causes an increase in transmitter frequency. The 6AG7 modulator tube receives its input voltage from one of the coaxial lines in the connecting cable. A peak-to-peak input signal of .65 volts from the transmitter control unit is sufficient for normal modula-



FIG. 14. Rear of the transmitter control unit. Front and rear covers are of the snap-on type, easily removed.

tion of the transmitter. The frequency characteristic of the overall system is flat from 60 cycles to 6 megacycles. The phase-shift at low frequencies is low enough so that a 60 cycle square wave at the input will appear in the output with less than 5% tilt.

A wavemeter (left center in Fig. 11) coupled into the waveguide, provides a reference for transmitter frequency calibration. This wavemeter is made of invar to minimize temperature effects, and is sealed to eliminate humidity effects. A crystal detector is also coupled into the wave guide. The d-c output of the crystal—which is a measure of the transmitter output—can be measured either at the transmitter or at the transmitter control location. The a-c output of the crystal—which gives an indication of the type of modulation (and hence can be used to monitor modulation)—is amplified by a buffer amplifier and sent over one of the coaxial lines to the transmitter control.

TRANSMITTER CONTROL UNIT

The transmitter control components and the regulated power supply are assembled on a rack-width, bathtub-type chassis (Fig. 13) which may be mounted on a standard relay rack or in a suitcase-type carrying case as shown in Fig. 12.



FIG. 15. Receiver case with outer cover removed to show cable connection and metering jacks. Note also the vernier adjustment of "cavity tuning," which is provided on this panel.

The controls incorporated in this unit are mounted on a small sub-panel behind an opening in the carrying case. One of these controls provides a means of adjusting the transmitter modulation. Another switches the output from the normal video voltage to either of two 60-cycle test voltages (of fixed amplitude) which are used to check deviation and output of the transmitter.

The regulated power supply provides 300 volts for the oscillator and modulator tubes, and a regulated negative supply for the oscillator reflector voltage. This can be adjusted from -200 to -100 volts with a normal output of 5 m.a. Both supplies maintain a substantially constant output voltage for an input variation of 100 to 130 volts. Total power required from the a-c line is 150 watts.

DESCRIPTION OF RECEIVER

The receiver chassis, which is mounted in the cylindrical case on the back of the receiver parabola, contains the heterodyne oscillator, the first detector, and four i-f stages of the receiver. This chassis is mechanically similar to the transmitter chassis, and can be removed in the same way (Figs. 15, 16, 17). It is connected with the receiver control unit (which can be as far as 200 feet away) by a single connecting cable of the same type as the transmitter cable.

The heterodyne oscillator is a Type 2K26 Klystron, designed for operation in the band 6800 to 7050 mc. This oscillator beats with the incoming frequency to provide (in the crystal first detector) a difference frequency in the i-f bands of 110 to 130 mc. Four stages of i-f amplification follow the detector. The output of the fourth i-f stage is fed to the receiver control unit over one of the coaxial lines in the connecting cable.

Jacks are mounted on the receiver chassis so that crystal detector current and the grid current of the i-f limiter stage in the receiver control unit can easily be measured. By reducing the i-f gain (by turning a knob on the receiver control unit) until the grid current in the limiter stage is reduced to half normal value, the setting of the gain control will indicate relative input signal.

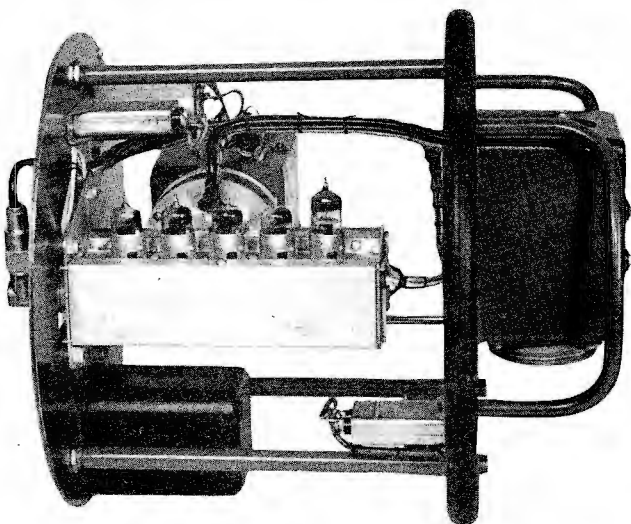

FIG. 16. Left side of the receiver chassis showing the four stage i-f "pre-amplifier," which amplifies the i-f signal to a level which can satisfactorily be sent over a coaxial line to the receiver control unit.

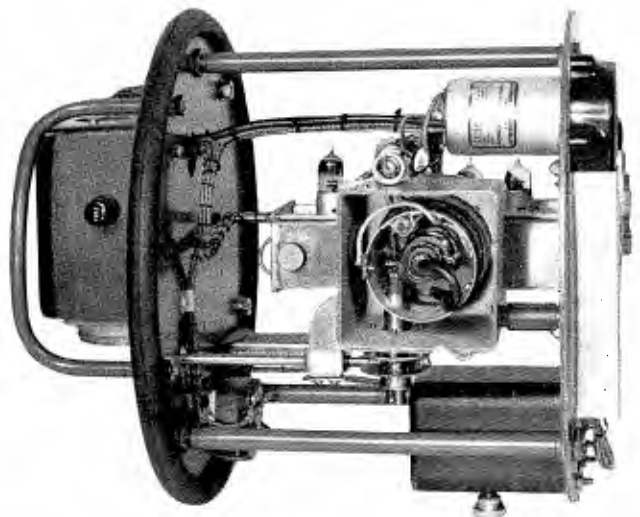

FIG. 17. Right side of the receiver chassis showing the Klystron oscillator (in small square box near center), which operates as a heterodyne oscillator beating with the incoming signal to provide a difference frequency of 110 to 130 mc.



FIG. 18. The receiver control unit includes additional *i-f* stages, two limiter-discriminator channels, a video amplifier, and monitoring circuits.

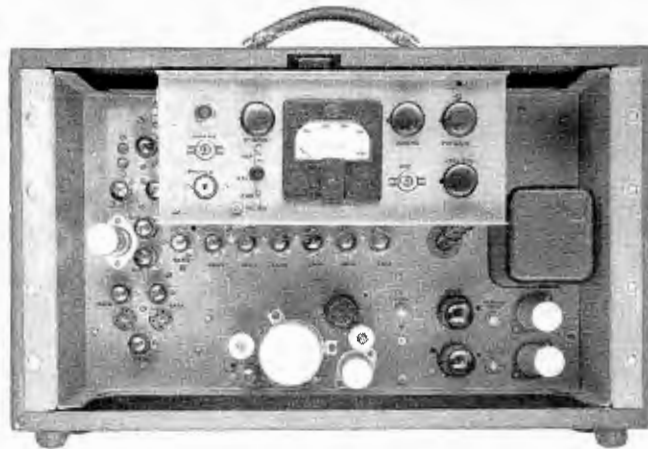

FIG. 19. Receiver control unit carrying case with front cover removed. All tubes and main components are on front of chassis.

Thus, by using a meter to observe this current, it is possible to adjust the orientation of the reflector in order to obtain maximum output signal.

RECEIVER CONTROL UNIT

This unit receives the signal at *i-f* frequency (from the receiver proper) and amplifies it sufficiently to operate satisfactorily the limiter and discriminator circuits. Two separate discriminator channels are provided. Each channel contains a limiter circuit, a balancing circuit, and the discriminator circuit proper. The first channel supplies video signal to the video amplifier. The video amplifier feeds two outputs. One of these is the regular output line to studio control room (or the main transmitter, if the receiver is located at the station). The other supplies signal to the monitor control circuits. The second discriminator channel is used to generate a control voltage for the AFC amplifier. The output of this amplifier is used to control the frequency of the heterodyne oscillator. It operates in such a way that the peaks of the synchronizing signal appear at the same point of the discriminator characteristic within ± 1 mc regardless of picture content. The AFC amplifier is a special type of d-c amplifier which receives a d-c signal varying at a relatively slow rate, and amplifies this to supply a control voltage to the heterodyne oscillator. This control system will keep the receiver in proper adjustment for a change in transmitter frequency of ± 20 mc. The control of the voltage output of the AFC amplifier is the main adjustment on the heterodyne oscillator frequency and, therefore, the timing of the receivers. A plug at the rear of the receiver control unit permits the location of a vernier control of frequency and an on-off switch on the AFC amplifier at some distance from the receiver. This allows routine tuning of the receiver at a console location where a monitoring kinescope and oscilloscope may be located.

Power supply for the receiver and receiver control unit is obtained from a separate unit: this is a standard RCA Type 580-C Power Supply which is similar in construction and size to the receiver control unit, and like it, may be mounted on a standard rack or in a suitcase-type carrying case.

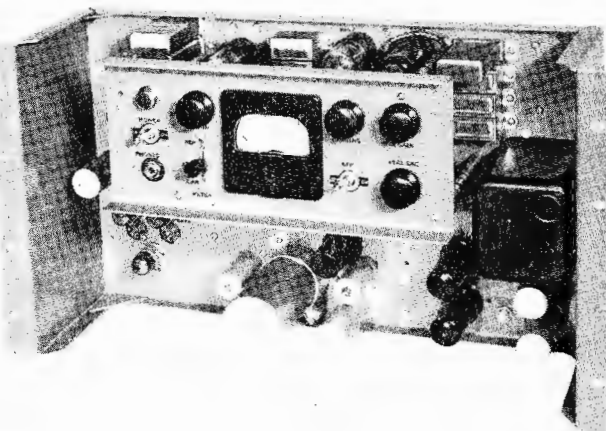

FIG. 20. The receiver control unit is assembled on a standard bathtub-type chassis which may be mounted on a standard rack or in a carrying case as shown above. The power supply, a separate unit, may also be rack-mounted or mounted in a case similar to that shown here.

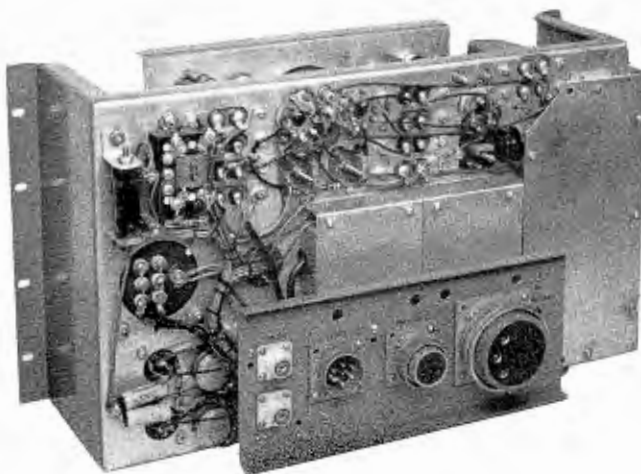

FIG. 21. Rear of the receiver control chassis showing wiring, connections and shielding of low level stages.

ENGINEERING PRODUCTS SALES EXECUTIVES

THEODORE A. (TED) SMITH'S promotion to the post of General Sales Manager of the Engineering Products Department of the Radio Corporation of America was recently announced by W. W. Watts, Vice President in charge of the department.

A native of New York City, Mr. Smith received a mechanical engineering degree from Stevens Institute of Technology in 1925, and immediately thereafter joined RCA's Technical and Test Laboratories at Van Cortlandt Park, New York.

Placed in charge of television engineering for RCA in 1928, he played a major role in building RCA's pioneer television station, W2XBS in New York. Now known as WNBC, the station is the oldest television transmitting station in the country.

Mr. Smith entered commercial engineering work in 1930 as RCA district sales manager for broadcast equipment, working out of New York and covering the eastern United States.

Assigned to RCA Victor's Camden headquarters in 1938, he held key sales engineering posts in connection with the sale of broadcast transmitters, television equipment, the electron microscope, and test and measuring equipment. Since 1943 he has been sales manager of Communications and Electronic Equipment of the RCA Engineering Products Department.

In his new post he will be in charge of all sales activities of the Engineering Products Department, including those of the Aviation, Broadcast, Television, Test Equipment, Sound, Theatre, 16 MM, Scientific Equipment and Electronic Apparatus Sections.



T. A. SMITH
General Sales Manager



A. R. HOPKINS
Manager, Communication Equipment Sales

A. R. HOPKINS, former Engineering Products Regional Manager in Chicago, has been promoted to the position of manager of Communications and Electronic Equipment Sales. "Hoppy," as he is known to hundreds of broadcasters, thus steps into the job vacated by Ted Smith (see above) and will make his headquarters in Camden, N. J. In his new position he will direct sales of the group of product lines which includes, broadcast, television, test, scientific and electronic equipment.

Mr. Hopkins graduated from Ohio State University in 1926; joined Day-Fan Electric Company the same year. In January 1929 he accepted a position with the Technical and Test Department of RCA and has been with the company ever since.

From 1930 to 1934, Mr. Hopkins was a member of the Centralized Radio and Photophone engineering groups. In June 1934 he was placed in charge of Speech Input Equipment engineering, a position he occupied until September 1935, at which time he transferred to the Broadcast Equipment Sales Section. From then until June 1937 he handled sales contacts and field liaison from the Camden office.

In 1937, Mr. Hopkins was placed in charge of broadcast equipment sales in Central District and occupied this position until 1942. During this time he made the acquaintance and friendship of nearly every broadcaster in the midwest. In 1942 he was appointed Engineering Products Regional Manager for the Chicago Region, a position he held until the present time.

BROADCAST AND TELEVISION SALES MANAGERS

DANA PRATT has recently been appointed manager of Broadcast Sales. In this position he supervises the sale of AM and FM transmitters, audio equipment, antennas and phasing equipment.

Dana's interest in radio started while he was still in high school during 1927. He obtained his first amateur license (W9GBL) in 1929. Since then he has held calls W9BGL, W9ELY and W3FWM—and expects soon to be on the air with the call W2QCV. In 1934 he received a degree in Electrical Engineering from the University of Kansas, and a Bachelor of Music Degree (in piano) from Washburn College. During the last year of college, he also worked the "graveyard" shift at WIBW and was active in the Kansas National Guard.

Mr. Pratt joined RCA in 1935 in the Transmitter Test Department. He was transferred to the RCA Service Company in 1937 and was responsible for a number of installations including the first 5-D transmitter at WJDX at Jackson, Miss., and one of the early type 50-D transmitters at WWL, New Orleans. In 1940 he was transferred to the Broadcast Equipment Sales Department and was located in Chicago during 1940 and 1941. During the war he handled RCA's crystal activities, a program that required an expansion of 30 to 40 times pre-war production. He returned to Broadcast Audio activities in 1944, handling this together with crystal activities. Since October 1945 all of his efforts have been devoted to Broadcast Equipment Sales.



DANA PRATT
Manager, Broadcast Equipment Sales



HENRY RHEA
Manager, Television Equipment Sales

HENRY RHEA, manager of the Television Engineering Section, supervises the sale of television transmitters, video equipment, antennas, relay equipment and other items used by television broadcast stations.

Henry's interest in radio dates from the amateur license (W9UJT) which he obtained while still in high school at Clinton, Illinois. In 1935, he graduated from the University of Illinois and immediately joined RCA in Camden. His first job was with the transmitter test section. A short time later he transferred to the Television Engineering Department where he worked on the development of cameras and camera circuits. He also assisted in the design of the first television field equipment, of which completed sets were built for NBC, Don Lee and others.

In 1940 Mr. Rhea transferred to the Sales Department where he handled sales of television, measuring equipment and electron microscopes. When the war began he was lent back to engineering to work on special fire-control radar systems for the Navy.

In 1943 he returned to Sales and during the remainder of the war handled RCA's airborne television program, which included the production of more than 4000 camera-transmitter units (otherwise known as "BLOCK" equipments). One of the accomplishments of this wartime development was the Image Orthicon pickup tube. During this period Mr. Rhea was RCA's representative on NDRC Section 5.3 which was responsible for developing television-guided missile equipment.

Transmitter Sales Group WESTERN REGION

Office: 621 S. Hope St.
Los, Angeles 14, Calif.



C. L. LaHAR, better known to his friends as Larry, is Engineering Products Manager for the Western Region. A New Englander by birth, Larry acquired an engineering education in Boston; joined RCA Photophone in 1929. Four years later he was appointed RCA Service Manager in Seattle. Later he spent two years as San Francisco service manager, and several years as sales representative on test equipment, photophone, sound, communication and broadcast equipment. He was appointed Engineering Products Regional Manager in 1945.

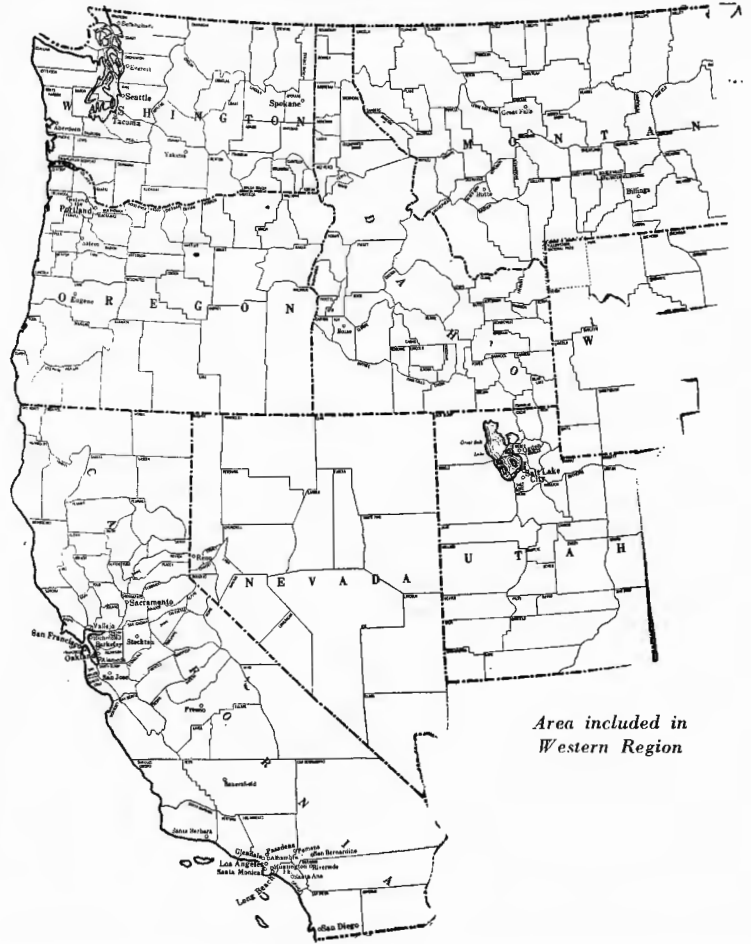

*Area included in
Western Region*



E. FROST is in charge of Broadcast Sales in the Western region. Before coming to RCA in 1933, Mr. Frost spent several years at GE on design, test and installation of transmitters. From 1933 to 1942 "Jack" handled RCA Broadcast Sales in San Francisco. In 1942 he was recalled to Camden to handle RADAR and similar products for the armed forces. He is now back on his old beat, but with headquarters in Los Angeles.



R. J. NEWMAN started his radio career in 1938 as an operator at KOAC. Dick joined the Broadcast Engineering Section of RCA in 1940. From that date until 1945 he was continuously engaged in the design of FM and AM broadcast transmitters, communications transmitters, and during the war, RADAR equipment. He transferred to Broadcast Sales about a year ago and is presently assigned to the San Francisco office.



C. W. TURNER is a real television expert, having been active in television since 1939. "Wes" joined NBC in the Hollywood engineering department in 1940, and was transferred to New York television operations in 1941. Assigned to NBC's television engineering lab he worked on various television developments. In 1944 he came to RCA as television equipment salesman and in 1945 was assigned to the Los Angeles office.

Transmitter Sales Group CENTRAL REGION

Office: 445 N. Lake Shore Drive,
Chicago 11, Ill.



*Area included in
Central Region*



C. M. LEWIS is Manager of Engineering Products Sales in the Midwest Region. "Buck" started as an amateur in 1920 (call 9CCS); was engineer of KFKU and WREN from 1929 to 1934. He joined RCA's transmitter engineering group in 1934, transferred to Broadcast Audio sales in 1937. During the war he handled RCA's radar sales to the services. In 1945 he was appointed Broadcast Equipment Sales Manager, a position he held until his recent appointment as Engineering Products Regional Manager.



E. C. TRACY graduated from Pratt Institute in 1938. In 1939 and 1940 he was assigned to the Television Engineering Staff at the World's Fair. From 1941 to 1944 Ed supervised aircraft radar installations for the Navy Bureau of Aeronautics in Newfoundland, Iceland, New Hebrides and Solomons. From 1944 to 1946 he supervised activities of RCA Service Engineers on Shipborne Radar. He transferred to Sales early this year and is assigned to Chicago.



P. H. CLARK has been active in broadcasting since 1928 when he started with WBZ. Paul joined the engineering staff of NBC in 1929, became a control room supervisor in the Chicago division in 1930, and remained with NBC until 1942, when he was commissioned a Captain in the Signal Corps. He was released from the Army as a Lieutenant Colonel in May 1945 and has been with the RCA broadcast sales section in the Chicago region since then.



DAVID BAIN was chief engineer for WTAL in 1936-37, and chief engineer for WRTD from 1937 to 1940. In 1940 Dave was named chief engineer of WBML, Macon. At the outbreak of the war he was called to Washington by the Navy Department and was active during the war in the Airborne Radar Design Section of the Bureau of Ships. He joined RCA in 1945 and is now assigned to Broadcast Sales in the Chicago office.

Transmitter Sales Group SOUTHWESTERN REGION

Office: 2010 Jackson St.
Dallas 1, Texas

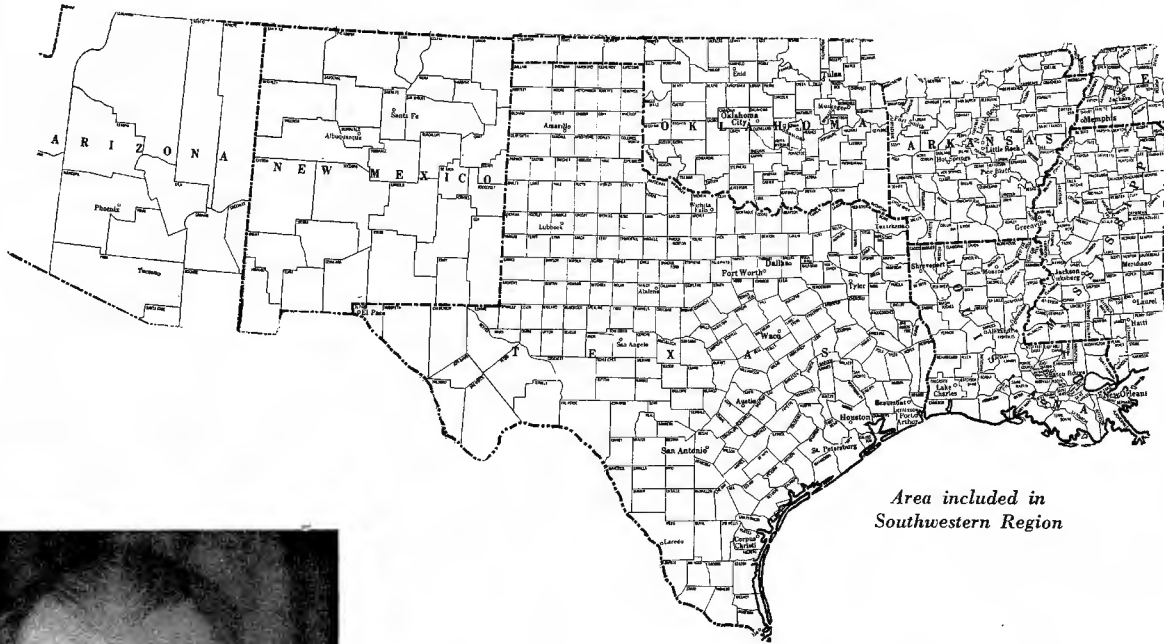

*Area included in
Southwestern Region*



W. M. WITTY needs no introduction to broadcasters in the Southwestern Region where he has handled broadcast equipment sales since 1932. A University of Kentucky graduate (B.S. M.E., E.E. '26), Bill spent two years with GE at Schenectady; joined the RCA Service Division in 1928. He was appointed Southwestern District Service Manager in 1929; transferred to the Broadcast Sales section in 1932. He makes his headquarters in Dallas where he has resided since 1929—except for the period 1942-45 when he was called to Camden to handle sale of radio frequency heating equipment to wartime industrial users. Since 1934 he has been in charge of RCA Broadcast Sales for the Southwestern Region.



HARRY HILL obtained his amateur license (5KI) in 1920, still has the same call. He started servicing receivers in 1923, joined KPRC in 1928. In 1933 he became Service Manager for Southwestern Victor. From 1935 to 1939 he was with GE as field engineer and District Radio Sales Manager. In 1940 he joined RCA on Communications Sales; spent the war years in Camden, and is now back in Dallas on Communications and Broadcast Sales.



F. J. KELLEY graduated from Purdue in 1938; spent the next three years on geophysical survey work in South America. He joined the engineering staff of WFAA in 1941, left six months later to enter the Signal Corps. He served with the RAF in England; with the AAF at Wright Field, at Boca Raton and on Guam, Saipan and Tinian. Joined RCA early this year and is assigned to Broadcast Sales in the Southwestern Region.

Transmitter Sales Group SOUTHEASTERN REGION

Office: 530 Citizens & Southern Bank Bldg.
Atlanta 3, Ga.

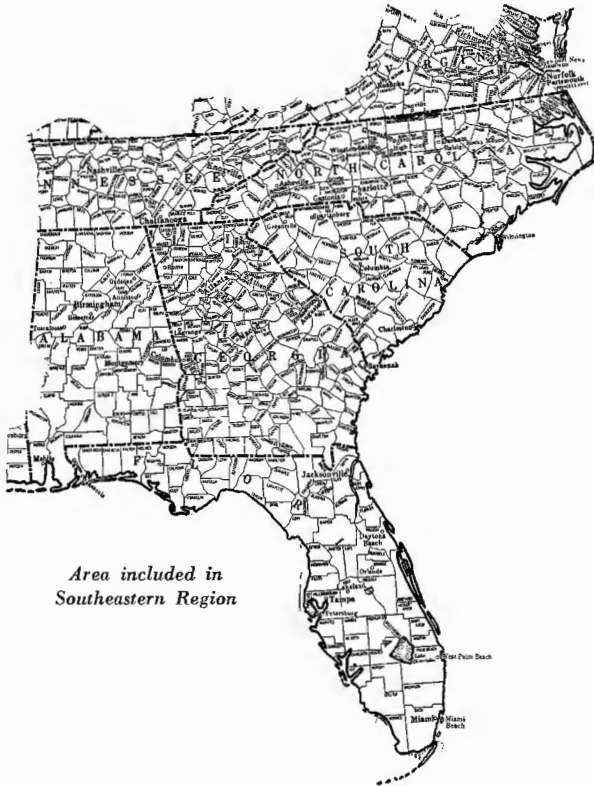

*Area included in
Southeastern Region*

WASHINGTON OFFICE
1628 K St. NW



P. B. REED originally joined RCA as a field engineer on Photophone Reproducing Equipment. In 1937 he was appointed District Sales Engineer for the Southeast, with headquarters in Atlanta. During the war he was active as a member of RCA's Field Engineering Group and served ten months with the 4th Fleet in the South Atlantic. "Pinky" (it's really Pinckney) is now responsible for broadcast sales and contacts in Washington, D. C., and vicinity.



P. G. WALTERS, JR. is manager of broadcast equipment sales for the Southeastern Region. "P. G." was connected with WNOX prior to joining the RCA International Sales Division in 1942. During the war he handled lend-lease and OWI broadcast equipment sales, including details of 50 KW installations, in the Belgian Congo, French Equatorial Africa, Rio de Janeiro and others.

Transmitter Sales Group EAST CENTRAL REGION

Office: 718 Keith Bldg.
Cleveland 15, Ohio



H. V. SOMERVILLE has recently been placed in charge of Engineering Products Sales for the Cleveland region. Harry joined RCA in 1929 as a student engineer, later served several years as Radiola and Photophone field service engineer. He was appointed sales engineer for Commercial Sound and Police Radio for the Kansas City district in 1937, and later was regional engineer for the Chicago region. In 1944 he was made Sales Manager for Industrial and Sound Products, and just recently Manager of all Engineering Product Sales for the Cleveland region.



J. H. KEACHIE, manager of broadcast equipment sales in the Cleveland region, can boast of more than 16 years of broadcast transmitter experience. As a member of RCA's transmitter development section, and later as field engineer, Jim has probably installed more of this country's broadcast transmitters than any other one man—and most of them were big jobs, fives and fifties. Broadcasters should find his experience a great help in planning new installations.



J. M. PRICE is another one of our Texas boys, although presently assigned to the Cleveland office. Jim attended Texas A. and M.; joined RCA in its Test Department in 1941. In 1942 he transferred to the Broadcast Sales group and was assigned to the Cincinnati office. Jim served with Navy Blimp Squadron 12 as Radio Technician from 1943 until March of this year when he returned to Broadcast Sales and was assigned to Cleveland office.



L. W. HAESELER started in radio with an amateur license (W3BBB) in 1929. From 1934 to 1936 he served on technical staffs of WRAW and WEEU. He graduated from Lehigh University in 1939 and entered RCA's training course. In July 1940 Len was assigned to Receiver Engineering, and in 1941 to Airborne Radar. In November 1945 he was transferred to the Broadcast Sales Section. He was assigned to the New York office in February of this year.

Transmitter Sales Group EASTERN REGION

Office: 411 Fifth Ave.
New York 16, N. Y.

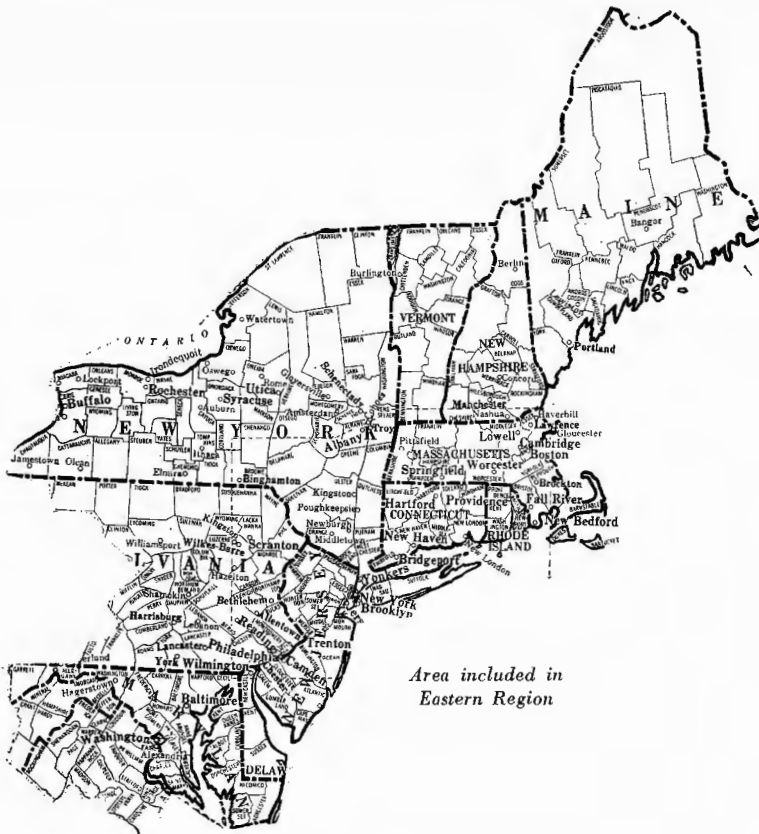

Area included in
Eastern Region



AL. JOSEPHSEN is manager of Engineering Product Sales in the Eastern region. Al joined the RCA Marine Department in 1920, acting as service manager in Washington, Chicago, and Dallas until 1928. Following this he was broadcast equipment sales representative for the Southwest and West coast areas. In 1935 he was transferred to the Chicago region, and in 1946 to the New York region. In his present position he is in charge, not only of Broadcast sales, but also of aviation, communication, sound, theatre and industrial equipment sales.



HARRY SADENWATER, one of the real pioneers of radio, has been a professional radioman since 1912. In 1919 he won the Navy Cross for participation in the first transatlantic flight. In the early twenties he was Engineer-in-charge of building pioneer stations KGO and KOA. For a number of years he was RCA's Television Project Engineer, later served on the staff at RCA Laboratories. His newest job is with the Broadcast Sales Section in New York.



R. I. MASON joined RCA photophone engineering in 1930. During the war, as a member of the Columbia University OSRD group, he played an important part in the development of anti-submarine detection devices which were widely used. He served in planes and submarines with the U. S. Navy; with the British in submarines; and with the R. A. F. Coastal Command. In his new position Russ contacts broadcasters in the New England District.



C. H. KLEINMAN made his start in radio with Free Laboratories in 1929. In 1934 he joined WNEW as an engineer; shifted to WABC in 1935; and served with CBS for the next six years. In 1942 he joined Metropolitan Television, New York, as program director of FM Station W75NY. He joined RCA as Broadcast Sales Engineer in New York region in 1945. A television enthusiast, Charlie is one of the Directors of the American Television Society.

And Now THE "PYLON"

A New FM Antenna Which is Simpler in Construction and Has Higher Gain Than any Type Previously Available

by **ROBERT F. HOLTZ**
Engineering Products Department

FIG. 1. (Below) The "Pylon" Antenna is made up of cylindrical sections which are 19½ inches in diameter, 13½ feet high. Two, four, or eight such sections may be stacked (see Figure 2) to provide high gain. Each section is fed at a single point midway on the slot. The structure is very simple, easy to erect and has higher gain (per height) than any previous type.

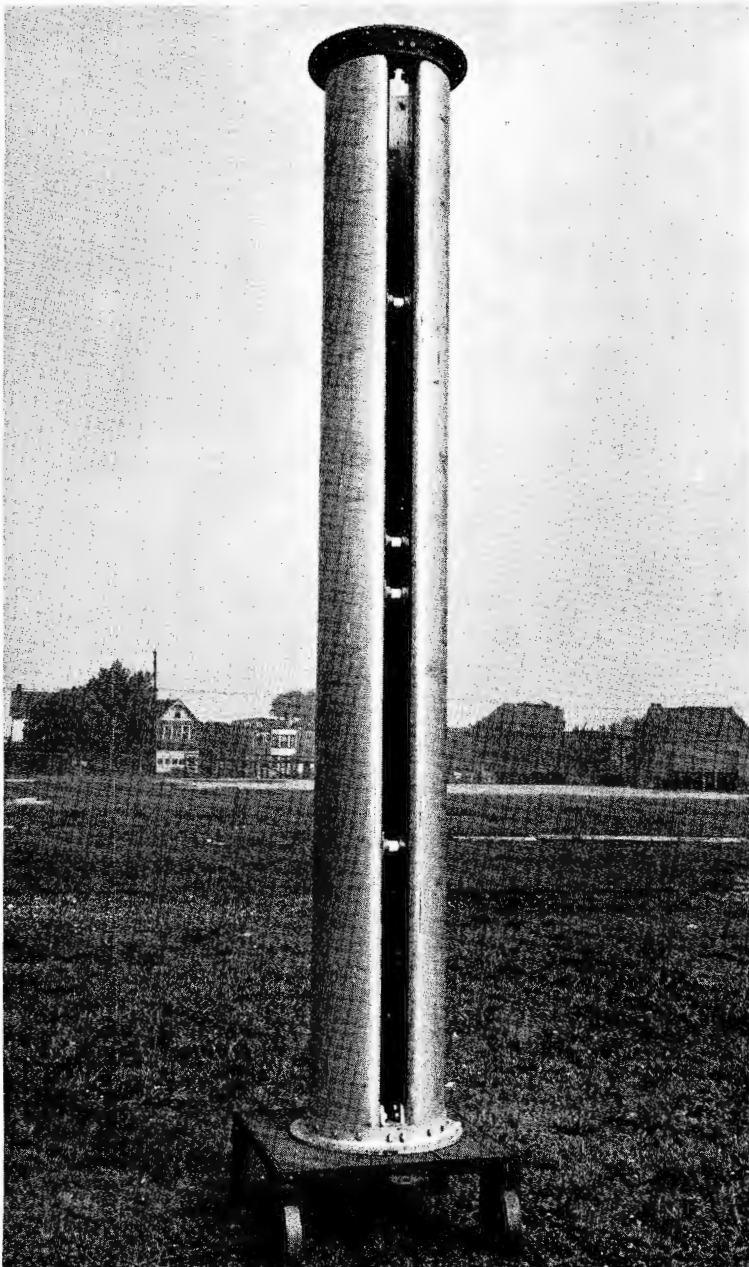

Newest of what is now a large family of FM antennas is the RCA Pylon. First announced only two months ago, this antenna has already achieved a popularity which indicates that it will be *the* antenna for most FM installations. The reasons are obvious—this new antenna is simpler in design, poses fewer construction problems and provides higher gain (height for height) than any other type.

WHAT IT IS

In the development of the Pylon antenna all previous concepts of high frequency radiation were abandoned. The result is an "out of this world" design which for simplicity and ease of erection can hardly be matched. Structurally, mechanically, and electrically this new antenna has been reduced to strictly functional elements. The Pylon is a cylinder approximately 13 feet high and 19 inches in diameter with a narrow slot cut from top to bottom (Figure 1). There are no dipoles, no loops, no appendages of any kind. The cylindrical structure itself, is the radiator. A single transmission line running up the inside of the cylinder, along the slot, to the midpoint is the feed line.

The cylinder is rolled from a single sheet of metal. It is capped on each end with a cast base which gives it great mechanical strength and provides a means of connection to the supporting tower or to additional stacked sections. As many as four, or perhaps more, of these basic cylindrical sections may be stacked to provide a high-gain antenna of remarkably simple design. (Figure 2.)

HOW IT WORKS

The operation of the Pylon may be best understood by considering the edges of the slot as an open wire transmission line which, when suitably excited, drives the cylinder as the radiating portion of the structure. The slot is approximately a wavelength long at FM frequencies, and the cylinder is about a half-wavelength in circumference. It will be helpful to think of the cylinder as being made up of a very large number of halfwave circular elements, as shown in Figure 3. If a voltage is impressed across an element of such dimensions, a current will flow in it and radiation will take place. Moreover, as the voltage is impressed on the radiating element at every point along the length of the slot, the entire length of the cylinder serves as the radiator. (Figure 4 gives a qualitative picture of the currents flowing in the cylinder and the voltages present across the slot.)

WHERE IT ORIGINATED

The cylindrical Pylon antenna has been undergoing development since early in 1944 at RCA in Camden. The principle of the so-called Slot Antenna has been employed in a number

ANTENNA

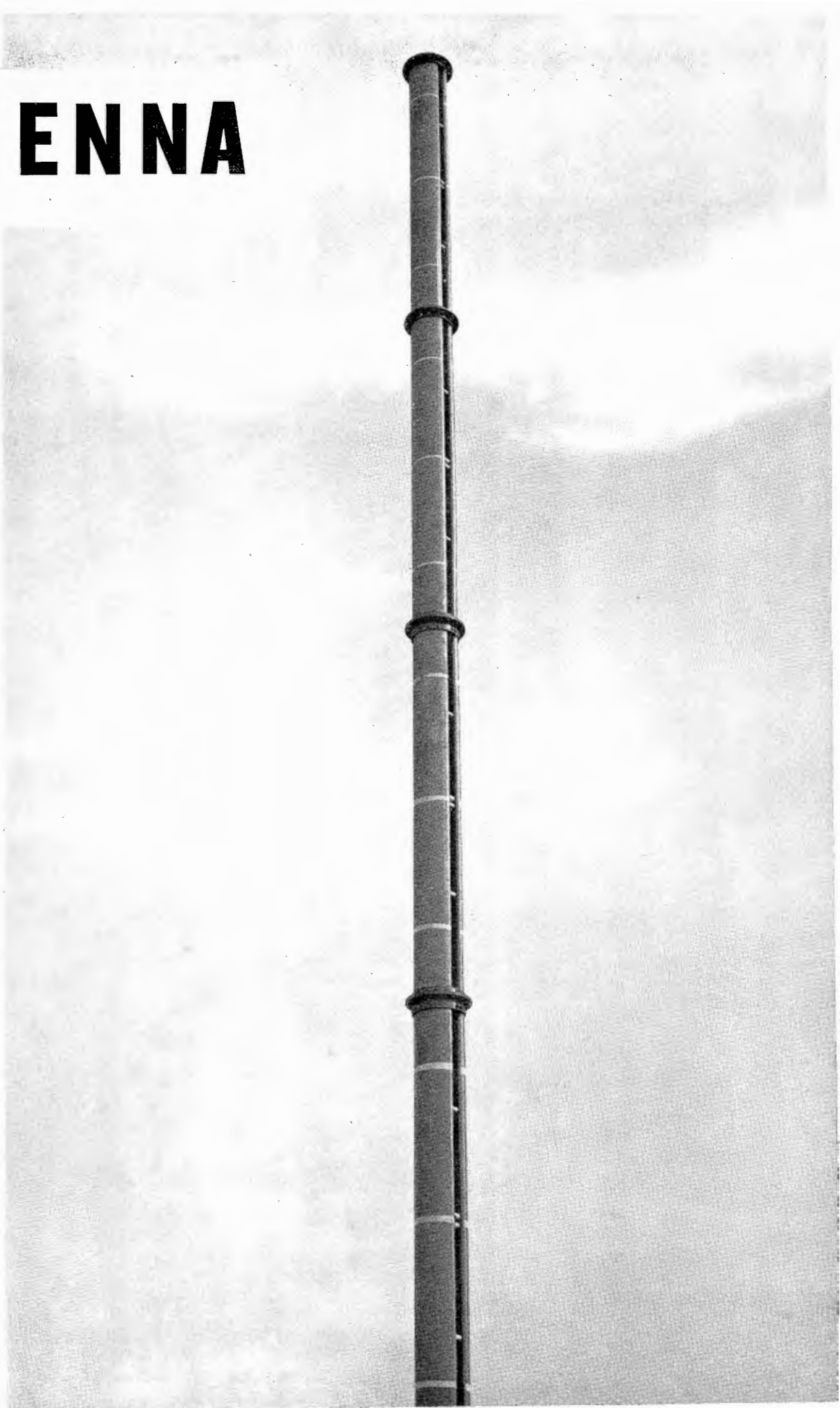

FIG. 2. (Right)
Pylon sections may be stacked to provide high gain. Shown here is a four-section Pylon having a power gain of six. As many as eight sections (power gain of twelve) may be stacked in this manner. The structure is self-supporting, relatively light in weight.

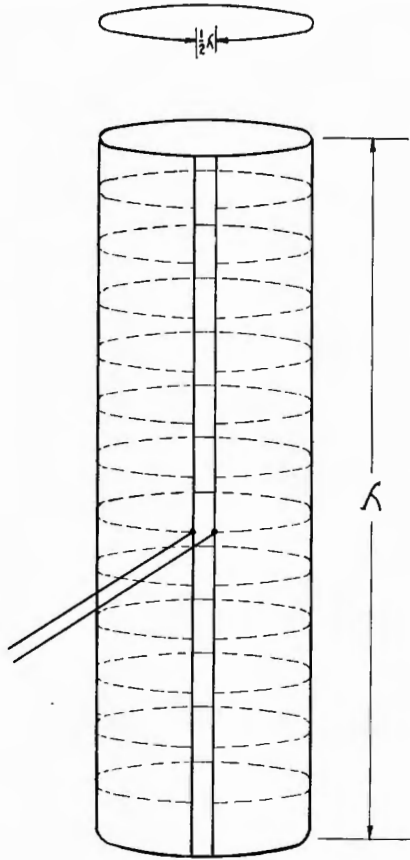

FIG. 3. The Pylon antenna may be considered as being made up of a large number of circular elements, each of which is a radiating member.

of applications where existing plane metal surfaces had to be adapted to radiating high-frequency energy. When it was recognized that these radiating surfaces could be rolled into a cylinder and used for the radiation of an omni-directional, horizontal polarized wave, steps were taken to explore the possibilities. Early tests were conducted on 200 megacycle models fabricated of light wire screen. Although the half-wavelength circumference, wavelength-long radiator may appear an obvious choice for such an antenna, this is by no means true. A given set of dimensions for a cylinder will yield a radiator which can be operated at any one of a number of modes. The cylinder diameter is intimately associated with the resulting horizontal pattern; on the other hand, the diameter is also a controlling factor in the length of cylinder for resonance. A compromise was struck at this stage of the development. Investigation revealed that the slot width could be used to control the absolute value of the impedance level at the feed point. This characteristic was carefully explored in order to arrive at an optimum design. Careful tests were carried out to make certain that a round cylinder yielded the optimum characteristics; no reasonable degree of ovality

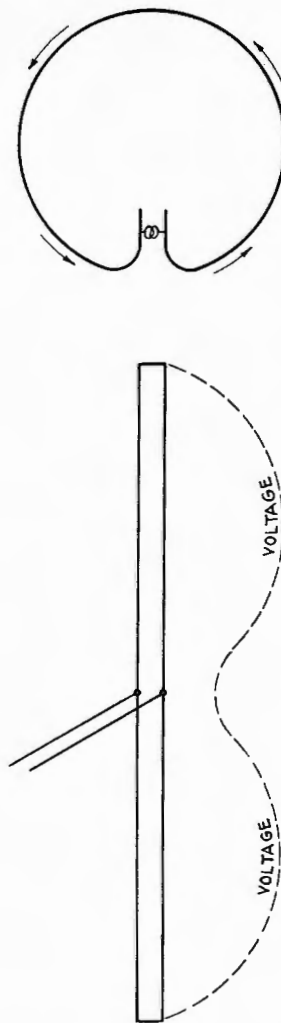

FIG. 4. Power is fed to the slot which functions as a transmission line. Currents flow around the circular paths as shown above.

improved the performance in any way. Multiple slot cylinders with more than one slot on the periphery were considered and rejected because the structural and electrical simplicity of the antenna were lost.

WHY IT MEETS FM REQUIREMENTS

The Pylon antenna has a number of features which make it ideal for FM broadcast station use. Briefly these are:

1. A SINGLE-ELEMENT SELF-SUPPORTING STRUCTURE. The Pylon requires no additional means of support or mounting (i.e. flagpole or center tower), such as required with all previous types of FM antennas.
2. IS EASY TO ERECT, being simply bolted by means of the bottom flanges to the building, tower, or other structure, which provides the necessary elevation. Additional sections are stacked on top of each other by bolting flanges together. There are no arms, loops, or circular elements with their attendant mounting and connection problems. (Figure 5.)

FIG. 5. The feeder system required with the Pylon is very simple. Heavy lines on the diagram at right show the arrangement of lines for 1, 2, and 4-section antennas. Note that there is only one feed point for each section. Moreover, since two sections with interconnecting line can be joined together on the ground, it is necessary to make only two or three connections "in the air." In every respect the Pylon Antenna is much easier to erect than previous types. There are no arms, circular elements or other appendages; there are fewer lines and the structure itself is much simpler and easier to handle.

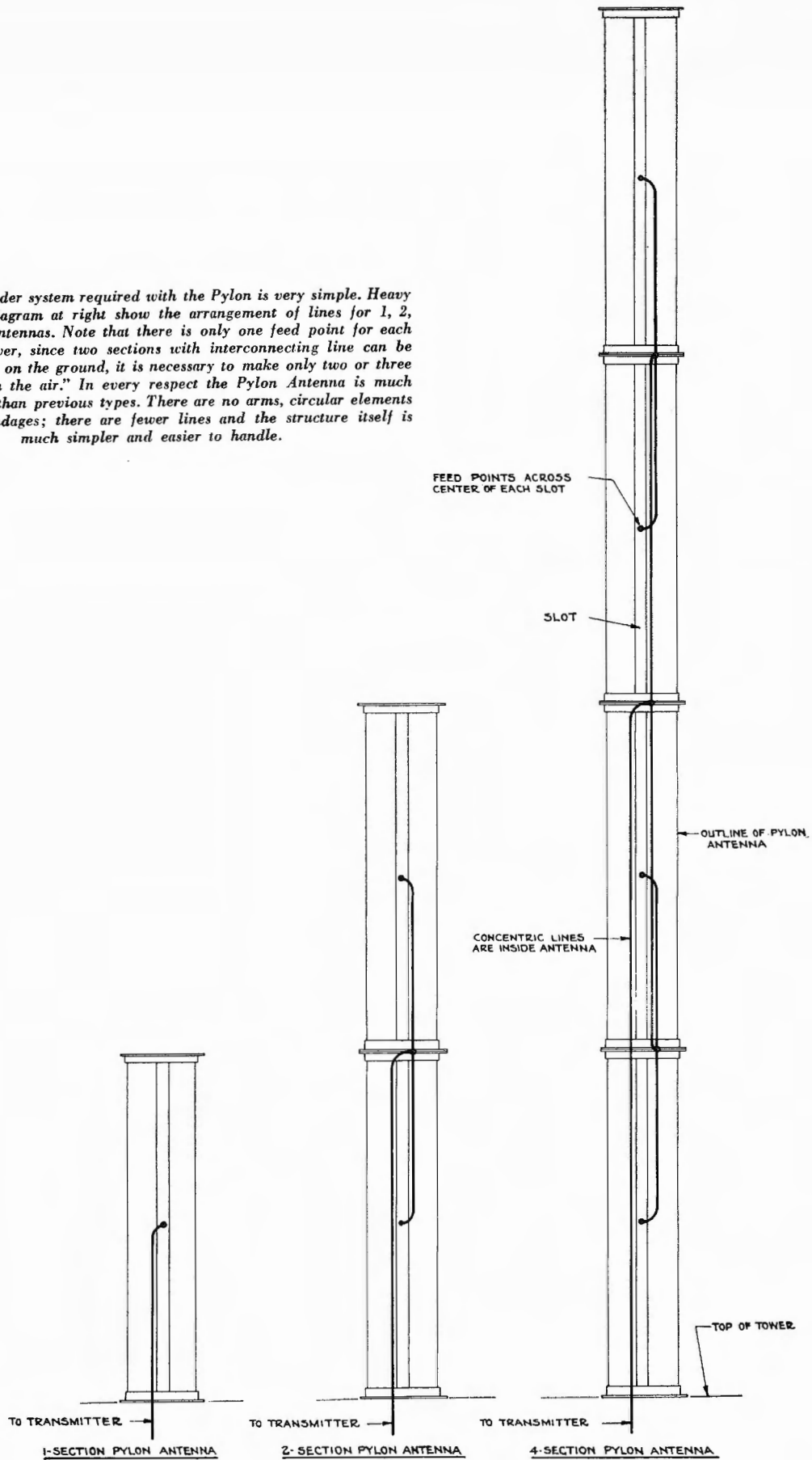

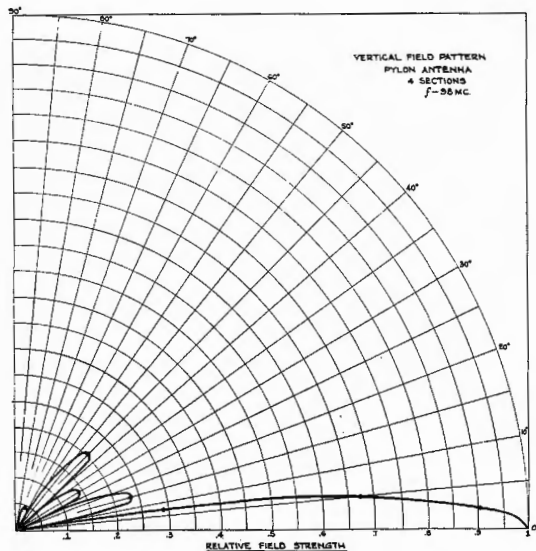
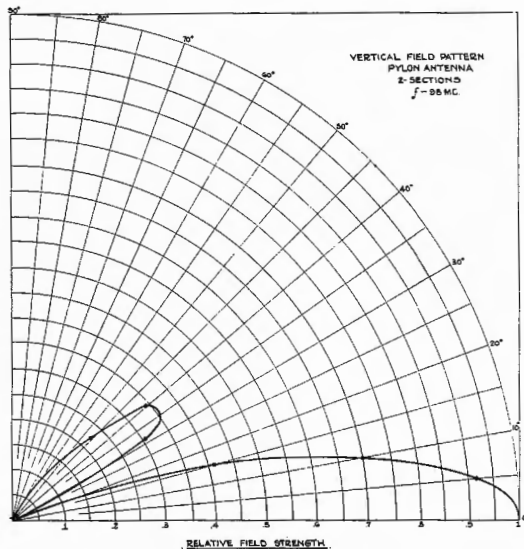
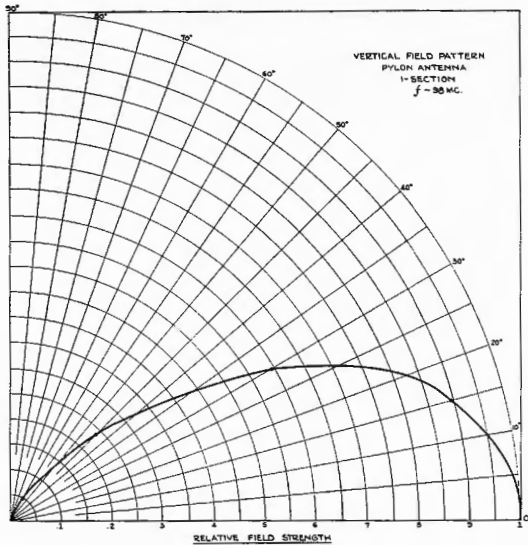

FIG. 6. The figures above show the relative suppression of skyward radiation (and increase in low-angle radiation) for 1, 2, and 4-section Pylons.

3. PROVIDES HIGH GAIN where needed. By stacking sections vertically, radiation is suppressed in the horizontal plane (Figure 6) with subsequent power gain. As many as four sections, possibly more, may be stacked to provide gains as shown in Figure 7. The horizontal pattern is essentially omni-directional (Figure 8).
4. GOOD FOR ANY POWER which FM stations may use, the Pylon is designed to operate with a wide safety margin at inputs up to 50 KW, which means, for example, a radiated power of 300 KW when four sections (power gain of 6) are used.
5. COVERS WHOLE FREQUENCY BAND with one size of radiator (cylinder) and two sizes of transmission line lengths. No tuning or adjusting is required either on the ground or in the air. Wide bandwidth is obtained by use of line elements (Figure 9).
6. LOW IN WEIGHT, this antenna places a minimum load and stress on the building or tower on which it is mounted. The single-section model (BF-11A) weighs only 350 pounds, the two-section (BF-12A) only 700 pounds. The four-section (of heavier material) weighs 2000 pounds. These weights include radiator, transmission lines, beacon, pole steps and hardware.
7. MECHANICALLY STRONG AND STIFF, the Pylon can be safely mounted anywhere; there are no appendages, separate radiating elements or other parts which wind storms might loosen with danger to personnel and property.

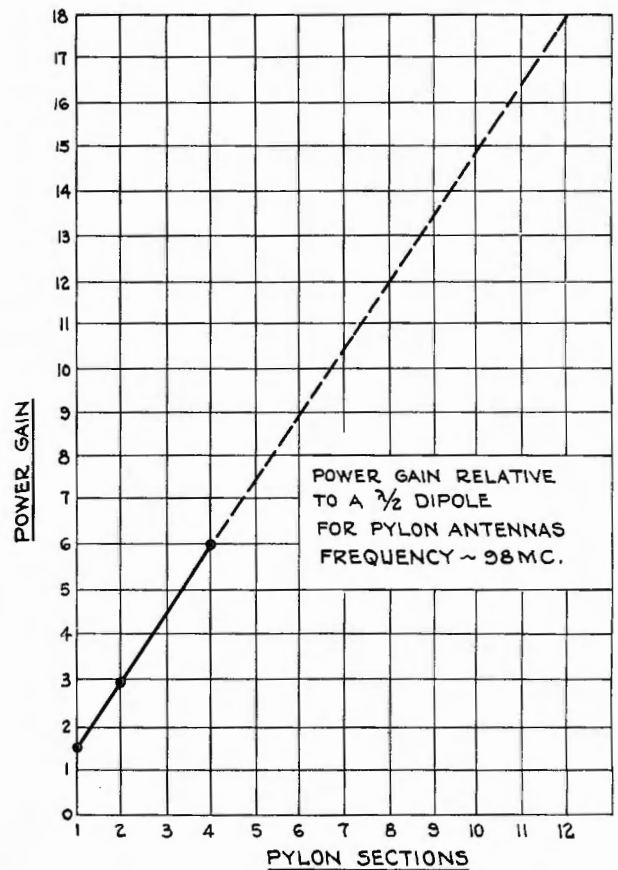

FIG. 7. Power gain of the Pylon Antenna as compared to radiation from a half-wave dipole. Height-for-height these gains exceed other types.

8. ONE FEED POINT PER SECTION is all that is required with the Pylon. (Note arrangement of feed lines in Figure 5.) Moreover, where two sections are used these may be joined on the ground, the interconnecting feed line mounted in place, and the whole assembly raised together. When this is done only one transmission line connection need be made "in the air." For a four-section antenna only three connections "in the air" are required. This compares with ten to fifty in other types of antennas.
9. NEGLIGIBLE ICE PROBLEMS are encountered with the Pylon because the transmission lines are inside the cylinder where ice formation is unlikely. Moreover there are no arms or other external elements which must be braced against ice loading. The formation of ice on the outside of the cylinder will add only a negligible amount to the weight and loading.
10. MAINTENANCE PROBLEMS ARE SIMPLIFIED by the extreme simplicity of the feed line arrangement, the small number of end seals and the fact that the lines are enclosed. Provision is made for mounting a standard 300 mm. code beacon on the plate which covers the top section of the antenna. Wiring to this light may be run either inside or outside the cylinder. Steps on the cylinder provide a means of replacing the light or servicing the lines (which can be easily reached through the slot).
11. FURNISHED COMPLETE with transmission lines, fittings, mounting flanges, and all hardware. The Pylon is a "package" item which provides everything the FM station requires, except of course, the building or tower to give the required height. Where desired RCA will also be glad to quote on towers and erection.

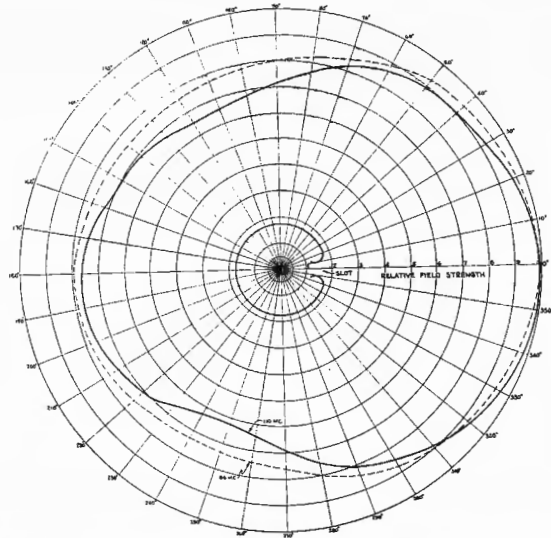

FIG. 8. Horizontal field pattern of the Pylon Antenna for frequencies at either end of the FM band.

FIG. 9. (Right) Broad band characteristic of the Pylon Antenna as indicated by curves of standing wave ratio versus frequency. Curve "a" is for direct connection of line to antenna; Curve "b" with use of simple stub matching section. Note that with latter arrangement the standing wave ratio is low across the whole band.

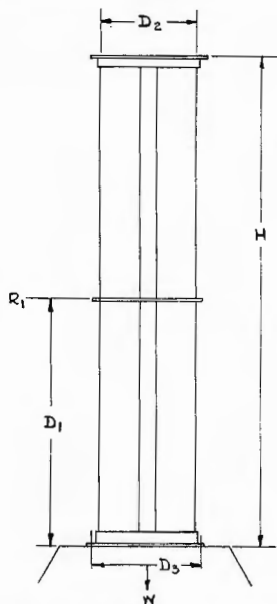
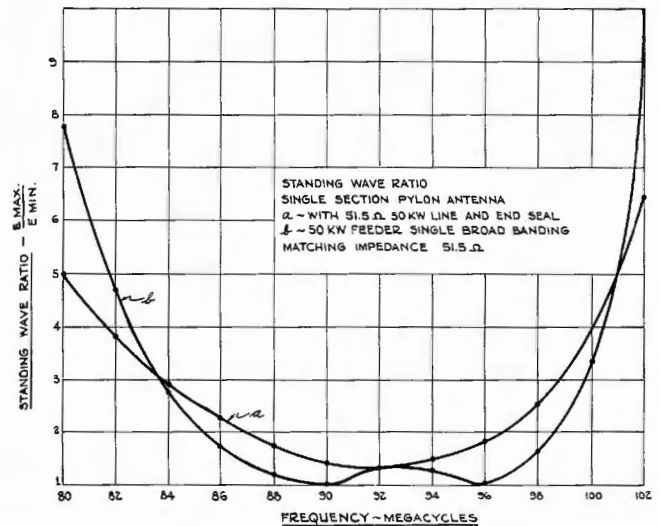

TABLE NO. 1
SPECIFICATIONS OF THE PYLON ANTENNA

Type No.	BF-11A	BF-12A	BF-14A
No. Sections	1	2	4
Power Gain (Nominal)	1.5	3.0	6.0
Field Gain (Nominal)	1.23	1.73	2.45
*W Lbs.	350	700	2000
H Ft.	13.5	27	54
**R ₁ Lbs.	501	950	1868
D ₁ Ft.	7½'	14'	27¼'
D ₂ In.	19½"	19½"	19½"
***D ₃ In. (bolt circle)	22⅜"	22⅜"	22⅜"

* W = Total weight including radiator, transmission lines, beacon, pole steps and miscellaneous hardware.
 ** R₁ = Total wind load on radiator including beacon and is based upon 20 #/Sq. ft. of projected area, all sections assumed rounds.
 *** Mounting is by means of 18¼" bolts on a 22⅜" bolt circle.

ISOLATION METHODS FOR FM ANTENNAS MOUNTED ON AM TOWERS

ROBERT F. HOLTZ
Engineering Products Department

Operation of FM and AM broadcast stations on a common antenna structure promises to find wide application throughout the industry. This is due to the substantial savings which can be effected in the initial cost of steel work and the cost of its erection. It is a fortunate coincidence that desirable heights of the supporting towers for FM stations fall directly in the range of existing and proposed heights of AM broadcast radiators; and further, the locations of such AM radiators are very often ideally located relative to the centers of population for optimum FM station coverage from omni-directional FM antennas. Although the nature of the propagation problems encountered in the two services differ, it remains a cardinal principle for both broadcast systems that the primary service area lies in the immediate neighborhood of the respective antennas.

For the shunt-fed AM tower, which is occasionally encountered, there is no problem other than the structural requirements imposed on the radiator by the addition of a top load due to the FM antenna. Since the base of such an antenna is grounded, the FM feed line can be connected to ground on the horizontal run from the station and fastened directly to the tower on the vertical run. The other conductor will rise in potential in the same manner as the structural members themselves; thus making

the entire FM antenna system an intimate part of the AM radiator. The only important effect on AM station operation will be the modified input impedance at the feed point due to the increased height of the tower. This can generally be corrected by minor tuning adjustments in the AM transmitter or line terminating unit.

The most commonly encountered AM antenna is a series-fed tower which is insulated from ground at the base. It is clear that an FM feed line cannot be connected directly to the ground on the horizontal run and to the tower on the vertical run without causing a short circuit in the base insulator. Therefore, some means of isolating the two systems at the base insulator is required. A number of suitable methods are available. Any scheme of isolation must eliminate the short circuit across the base insulator by raising the shunting impedance to a high value compared with the base impedance of the radiator itself. If the vertical run of the FM line is insulated from the tower for a quarter wave at the AM frequency (Figure 1), the impedance shunting the base insulator can be made infinite. This is true by virtue of the fact that the FM line and the tower represent two conductors of a shorted transmission line which is in shunt with the base insulator. The impedance of such a shorted line is given by:

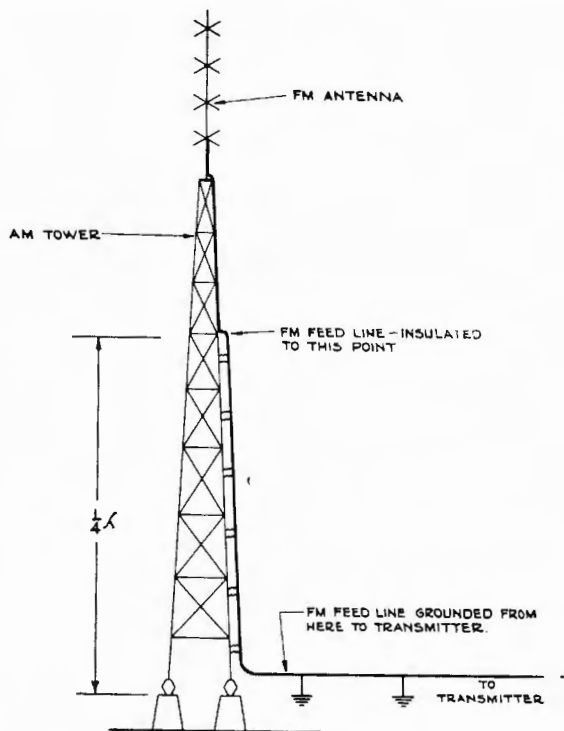

FIG. 1. Isolation provided by insulating FM line for one quarter wave up the AM tower.

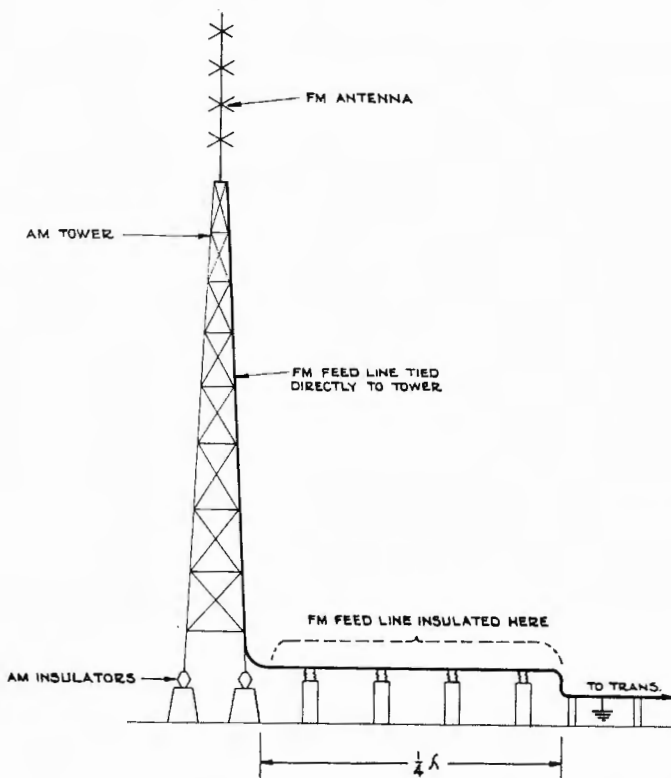

FIG. 2. Isolation provided by insulating FM line for one quarter wave along horizontal run.



FIG. 3. Exterior of the RCA FM-AM Isolator Unit.

$$Z = + Z_c \tan \alpha$$

where Z = shunting impedance
 Z_c = characteristic impedance
of the transmission line
 α = length of the transmission
line in electrical degrees.

If α is made equal to 90° (a quarter wave) \tan becomes infinite and so the shunting impedance is infinite. By the same token, if this FM line is fastened to the tower on the vertical run and insulated from ground for a quarter wave back to the station house on the horizontal run (Figure 2), the shunting impedance can again be made infinite. In this case the two conductors of the transmission line in shunt with the base insulator are the FM line and ground.

Cases will arise where the height of the tower is less than a quarter wave, or the distance back to the station house is less than a quarter wave. In this event the impedance in shunt with the base insulator is some finite value of positive reactance. This can be parallel resonated by shunting it with a capacitor whose reactance is equal in value and opposite in sign to the reactance due to the FM line and the tower or ground. Again an infinite effective impedance shunting the base insulator will result.

These methods in many cases, involve expensive mechanical hangers for supporting and insulating the FM line and, since it is above ground potential, protection against accidental contact with the FM line must be provided on the insulated horizontal run.

Other isolating schemes are possible by using networks of inductors and capacitors to connect the inner and outer conductors of the vertical and horizontal runs respectively of the FM line at the tower base. These networks are arranged so that their impedance at the AM frequency is infinite and at the FM frequency is zero. Such methods are often highly frequency selective and require careful adjustment at installation and occasional maintenance thereafter.

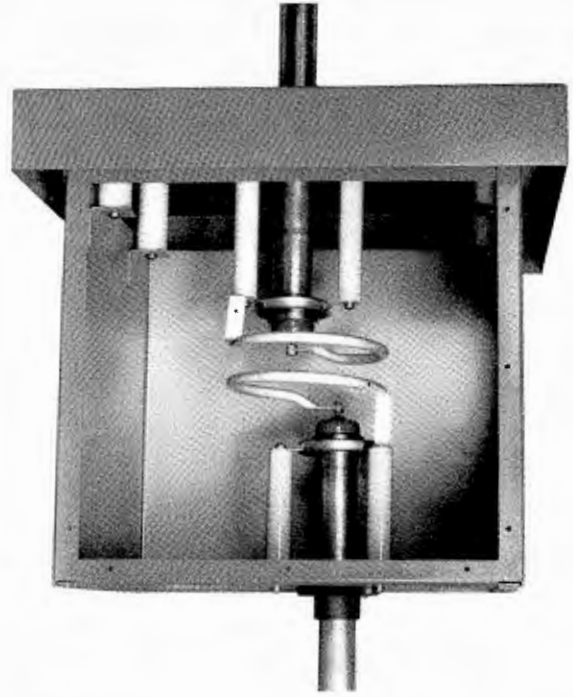

FIG. 4. Interior of the RCA FM-AM Isolator Unit.

Careful consideration of all factors indicated that a small, self-contained unit which could be installed at the base of the tower with the vertical run of FM line connecting to the top and the horizontal run of FM line connecting to the bottom, providing a high reactance in shunt with the tower base and requiring no tuning or adjusting after installation, was required. The RCA FM-AM Isolator has been developed to meet these requirements. Physically the Isolator consists of a weatherproof housing (Figure 3) approximately 18" x 18" x 20" with the top section insulated from the bottom and providing means for coupling to a $1\frac{5}{8}$ " transmission line at the top and bottom. The line from the transmitter enters the bottom of the unit and terminates in an end seal with a series resonant loop connected from the center conductor to ground (Figure 4). Closely coupled to this is a similar series resonant circuit terminating the line entering the top of the unit from the FM antenna. The degree of coupling and the self reactance of the elements involved are such that the Isolator efficiently couples the energy from the transmitter to the antenna. The design of the housing minimizes the capacity in shunt with the base insulator of the AM radiator. The result is a piece of equipment which effectively transfers the energy from the FM transmitter line (the outer conductor of which is connected to ground) to the FM antenna line (the outer conductor of which may be fastened directly to the tower) without short-circuiting the base insulator of the AM radiator. The unit has been designed for stability and broad-band frequency characteristics and requires no tuning or adjustment for the FM channel involved. Its power carrying capability is 10 KW in the 88-108 megacycle range; and ample safety factor has been provided for AM radiators with a base voltage of 10,000 volts. This will cover most radiators at powers of 50 KW in the 500-1600 kc range. Provision has been made to carry the concentric line gas pressure across the Isolator. The RCA FM-AM Isolator is rugged and simple, thus minimizing the installation and maintenance problems. It is efficient and stable, thus assuring performance and reliability. The unit is small and light, and requires no aligning or tuning after installation. Most stations will find it the simplest answer to their coupling problems.

"PLUG IN"

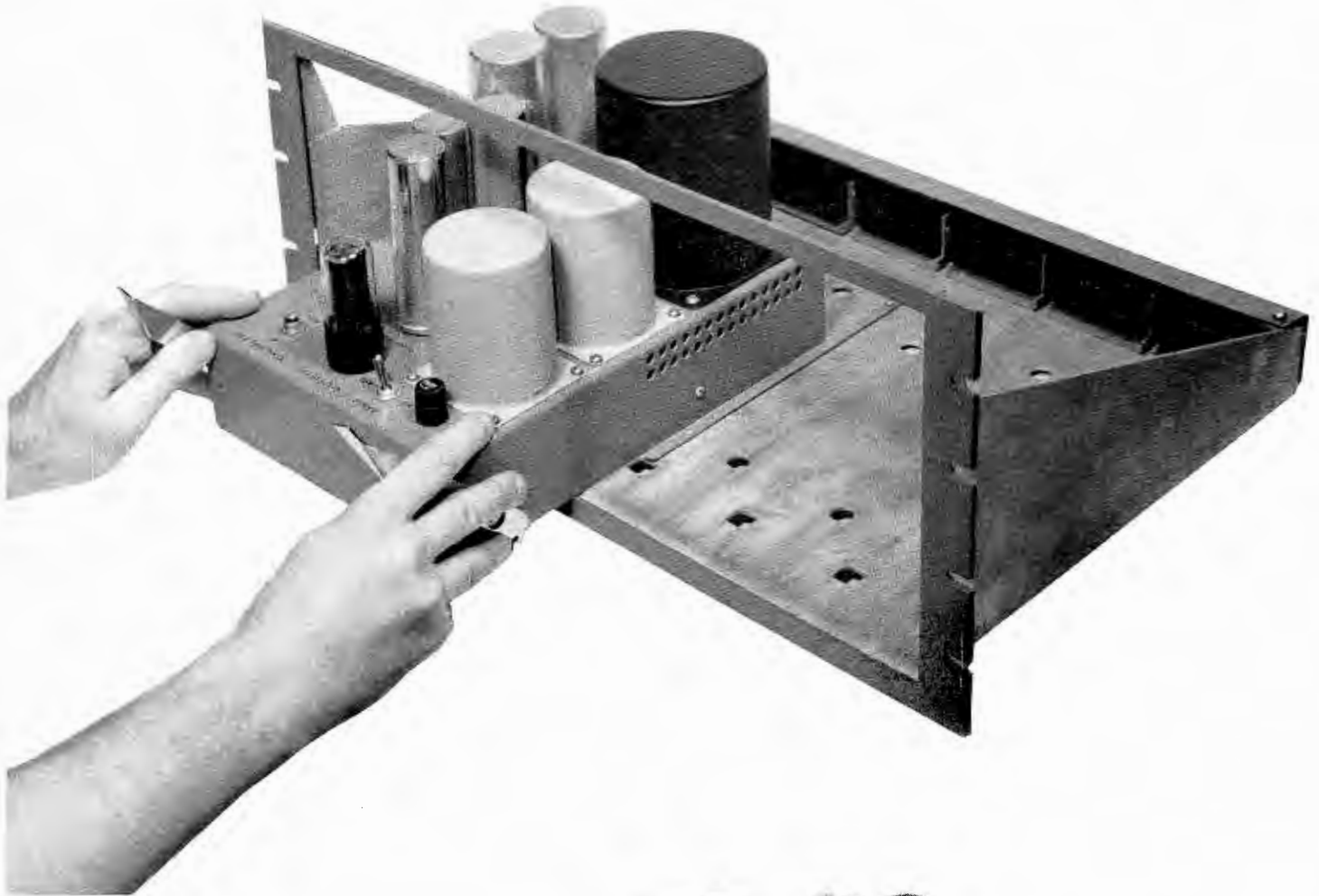

FIG. 1. *New RCA audio units are designed for "plug-in" mounting. Units slide into shelf, as shown above; can be replaced or interchanged at will. Installation and maintenance are greatly simplified, flexibility of the installation increased. Connections are made through ten-prong plugs at rear. Amplifier chassis locks in place by means of easy-action levers (in operator's hands, above).*

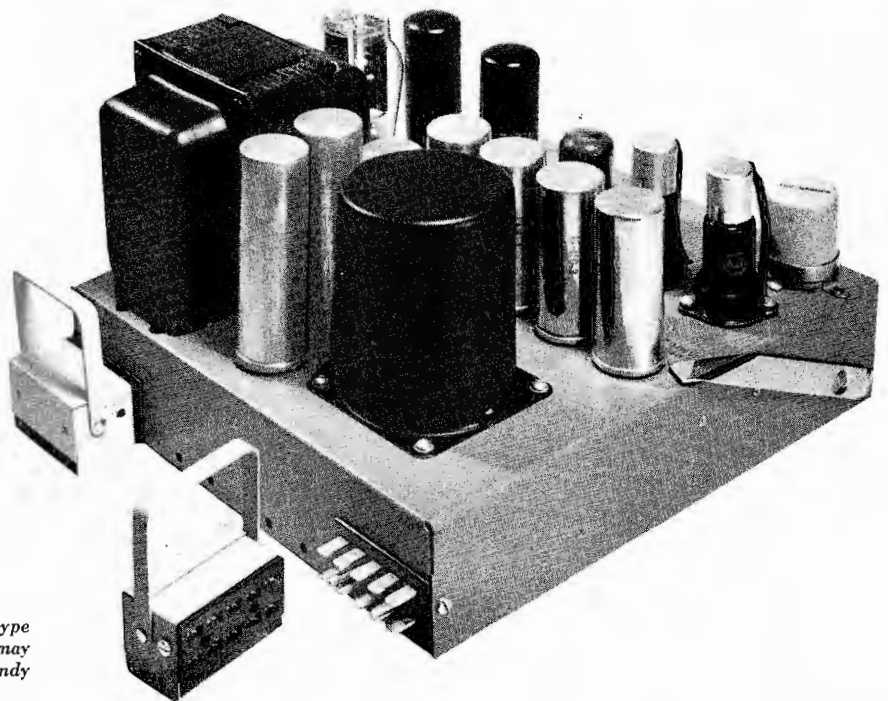

FIG. 2. *While especially designed for use with new Type BR-2A Shelf (see opposite page) the new amplifiers may be used with older shelf types by making use of handy receptacles shown in illustration at the right.*

AMPLIFIERS *for* *deluxe studio installations*

by **H. DUSZAK**

Engineering Department

RCA has developed a new line of amplifiers to provide the utmost in flexibility, accessibility, and ease of installation. These have been appropriately labeled "plug-in" amplifiers. (Figures 1 and 2.)

The superiority of plug-in amplifiers over those with conventional screw or solder-type terminals is readily apparent. A complete amplifier may be removed from the rack with no greater effort than is required to take a tube out of a socket. It is no longer necessary to crawl into the tight quarters behind the racks and unsolder or unscrew innumerable wires for servicing, inspection, or system changes. By pulling a lever near the front of the amplifier (Figure 1) the unit is disengaged from its socket, thus automatically disconnecting it from the supply voltage! This means that all amplifiers not actually in use may be handled without the danger of blowing the fuse or taking risks with the power supply circuits.

All of the amplifiers employ exactly the same standard plug and are made of black molded phenolic material, with two rows of five contacts each. Each contact is numbered and has a large bearing area which is heavily silver-plated. In the central por-

tion of each plug, two lightly-tapered guide pins, unequally spaced from the edges, are provided. These pins automatically guide the plug into its socket and, at the same time, obviate the possibility of reversed sockets. The plugs are located at the rear of the chassis in a rectangular hole which is of proper size to support them from all four sides. They are held in place with two screws through a supporting bracket or the side of the chassis, as the case may be.

The plug mates with a socket which has ten sets of phosphor bronze springs, which are also heavily silver-plated. (Figure 3.) The springs are split to provide at least four wiping contacts, so that there is strong wiping action on all sides of each prong of the plug. This insures good contact on each insertion. The socket also has two holes to receive the plug guide pins.

The RCA Type BR-2A Shelf (Figures 5 to 11) was especially designed for the new plug-in amplifiers. This shelf is made for mounting in a standard rack and occupies $8\frac{3}{4}$ inches of panel space. There are several ventilating holes in the shelf itself. Toward the back there are six groups of three holes each for mounting the brackets which hold the sockets mating the plugs

FIG. 3. *Closeup of the Type BR-2A Shelf with one Type BA-3A Program Amplifier in place. Guide strips, which are easily removable, are provided for centering unit so that plugs line up with receptacles; latter have some play so as to insure proper mating.*



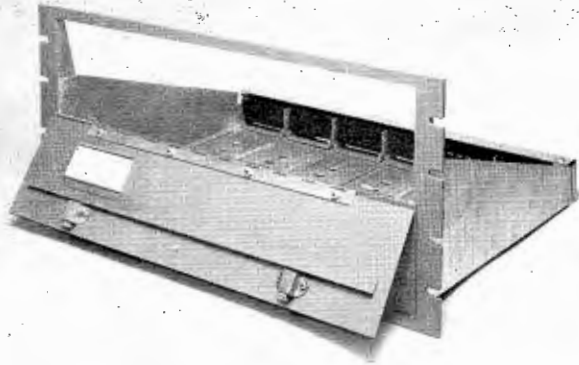

FIG. 4. BR-2A Shelf has front panel 8 $\frac{3}{4}$ " high—is designed to mount on old-type open racks or new RCA cabinet racks.

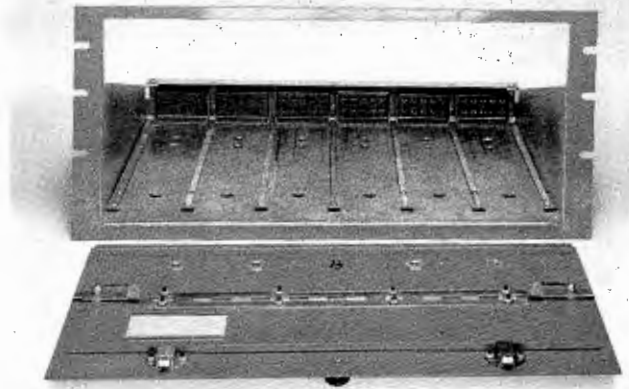

FIG. 5. Center section of BR-2A front panel is held in place by snap fasteners—can be easily removed.

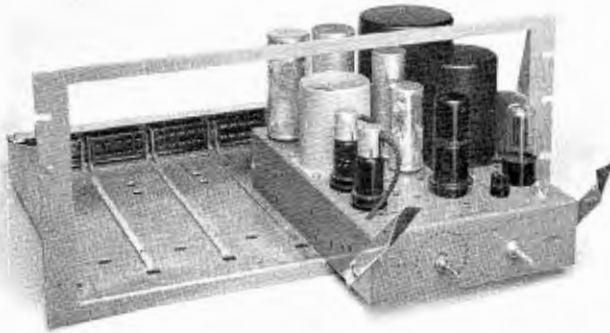

FIG. 6. With front panel of BR-2A removed, amplifiers easily slide into place. Guide strips on shelf insure proper positioning.

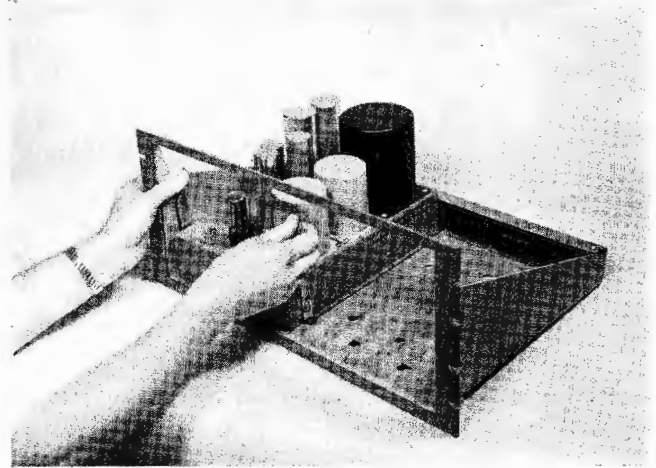

FIG. 7. Operator locks amplifier unit in place by pushing on levers as shown here. Pulling on levers loosens unit.

on back of the amplifiers. The holes are slightly oversize to permit small adjustment of the bracket so that the amplifiers may be perfectly aligned.

The brackets are made so that the amplifier base stops against the protruding bottom part of the bracket, thus eliminating any stress on the socket itself. In addition, the sockets are arranged so that they may float up and down slightly and also have freedom to "tilt" somewhat. (Figure 8.)

The design is such that the holes in the socket are always within the "reach", so to speak, of the guide pins on the plug. This insures smooth and easy connection every time. The wiring to the back of the sockets is protected by a steel terminal board cover which is held in place by two screws. (Figure 9.)

Toward the front of the shelf there are several square holes which are for the levers used to engage the amplifiers on the shelf. On each shelf there are also guide strips whose function is to properly align the amplifiers and to guide them into their sockets.

Either one or two ejector handles, depending on the size of the unit, are supplied with each amplifier. These levers are made of polished stainless steel which combines ruggedness with

good appearance. Both the chassis and the lever are dimpled, so that the head of the supporting pivot comes flush with the face of the lever. The pivot fits through a hole in the center of both dimples and is locked on the inside of the chassis by means of a "C" washer, which fits into a groove in the pivot, and is separated from the chassis by a light spring washer. The whole assembly may be easily added to or removed from the chassis. The top of the lever is formed inward so that one of the corners is at a 90° angle with relation to the rest of the handle. This arrangement keeps the lever from falling down and facilitates operation. The bottom part of the lever is especially designed to hook into a slot in the shelf, pulling the amplifier into place and holding it there. (Figure 7.) The back part is curved in such a way that the release is gradual, smooth, and rapid.

Although the plug-in amplifiers are primarily designed for the new shelf just described, they may be used with the Type 36-B panel and shelf. The amplifiers have holes in the back for adding the brackets which are supplied with each amplifier. If a Type 36-B panel and shelf are used, a small terminal board cover with a handle is included. The whole thing is screwed together into an assembly which may be disconnected readily.

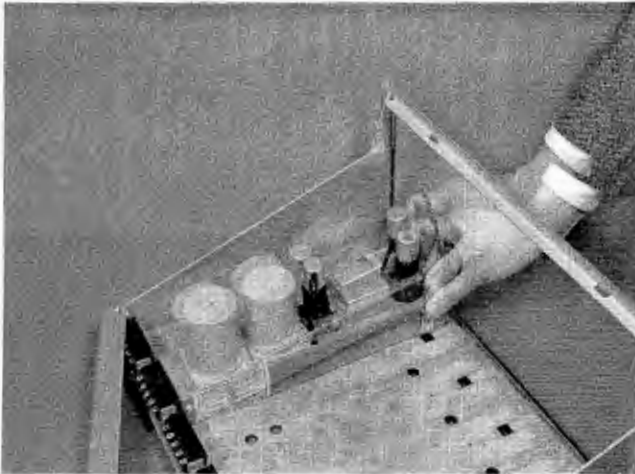

FIG. 8. Receptacles are not rigidly mounted on shelf, but have some play so that plugs will properly mate.

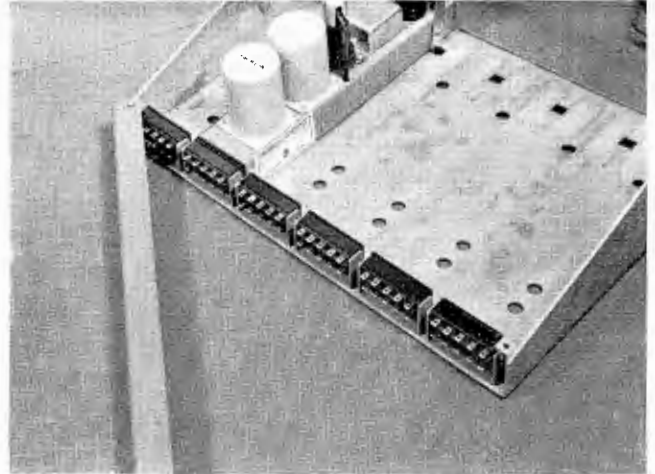

FIG. 9. Cover strip in rear of shelf protects wiring to receptacles. Note accessible position of all contacts.



FIG. 10. When mounted on rack, BR-2A Shelf with dial plates and control knobs looks like this.

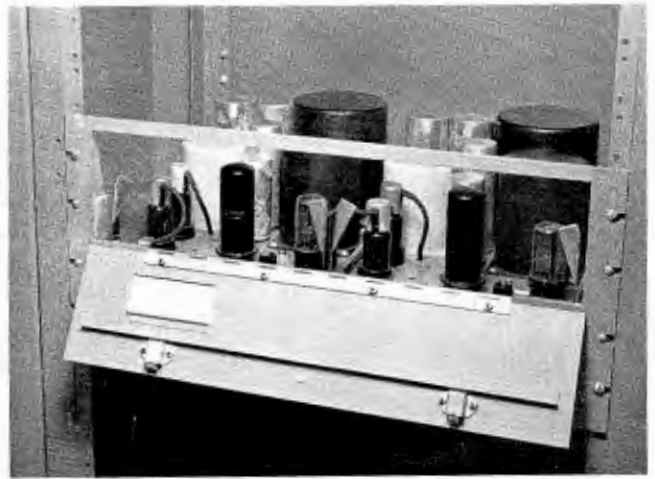

FIG. 11. Hinged upper half of panel is fastened by snap locks—can be quickly opened for access to tubes.

TYPE BA-1A PREAMPLIFIER

The plug-in amplifiers range in size from small preamplifiers to large monitoring amplifiers. The microphone preamplifier is Type BA-1A. (Figure 12.) This unit features more gain, better frequency response, and greater output than the earlier amplifiers of this type. The tube complement consists of two RCA-1620 tubes in cascade, operated as pentodes, thus supplying sufficient voltage amplification to allow for feedback over the two stages and still have a gain of 40 db.

The "IA" is rated at +10 dbm (0.001 W. Ref.) output. This rating is based on a distortion of $\frac{1}{2}\%$ for any frequency from 50 to 15,000 cps. It is important to note that this figure of distortion covers the full audio range and is not confined to a single midrange frequency such as 400 or 1000 cps.

The frequency response conforms with the requirements of a high fidelity amplifier—i.e. ± 1 db from 30 to 15,000 cps. In addition, there is an extra feature available. The response of this unit may be raised by about 1 db at both ends of the audio range. This is useful when used with a system involving a number of channels and/or several amplifiers in series. It allows balancing of the different channels and aids in achieving a flat overall response.

In order to make the Type BA-1A amplifier versatile, there is available the MI-11274 Bridging Volume Control Kit. This kit consists of a dual potentiometer in series with two 4,700-ohm resistors. Effectively, this provides a 10,000 ohm bridging input and a variable control. Under these conditions the maximum gain is approximately 7 db and may be readily reduced to unity gain, which is the normal operating condition. The isolation factor of the amplifier alone is around 90 db. If used with the Volume Control Kit, the isolation is well in excess of 100 db. Naturally, this unit also may be used as a booster amplifier in a multichannel network. The output transformer is hermetically sealed.

The normal power consumption of the Type BA-1A preamplifier is 3.5 ma. at 250 volts d-c for plate and screen, and 0.6 amperes at 6.3 volts a-c for the heaters. The plate supply, of course, must be adequately filtered so that the hum introduced in the preamplifier is held to a minimum. Adequate filtering is provided in the Type BX-1A Preamplifier Power Supply. (Figure 16.) This unit operates on a line voltage varying from 105 to 125 volts. It consists of a standard 5Y3 GT/G rectifier and a capacity input three-section filter. The first two sections employ chokes; the last one a resistor. The output is shunted

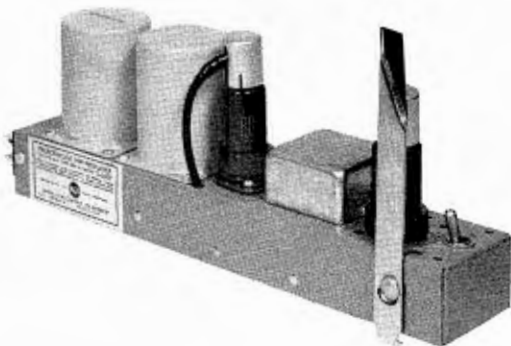

FIG. 12. Type BA-1A Microphone Preamplifier is a two-stage, low-noise amplifier with a gain of 40 db.

by 160 mfd of capacitance and a heavy rheostat is used to control the output voltage. In this manner, from one to six preamplifiers may be supplied with a single Type BX-1A power supply. The preamplifiers themselves have a certain amount of additional filtering which reduces the cross-talk, even under the most adverse conditions, to the range of the noise level, which is -80 db (0.001 W. Ref.). The cathode resistors are tapped and a switch is supplied for the purpose of metering the tubes in each stage.

TYPE BA-2A BOOSTER AMPLIFIER

The booster amplifier is Type BA-2A. (Figure 13.) This is a two-stage unit which uses two RCA-1620 or 6J7 tubes operated as triodes, and has a self-contained power supply. In the power supply there is a 6X5 GT/G rectifier. The gain of this amplifier is 50 db, and the noise level is -72 db (0.001 W. Ref.). With an interstage volume control there is a reduction in the noise level as the gain is decreased. The response is flat within $\pm 1\frac{1}{2}$ db from 30 to 15,000 cps. The same means is used for metering the cathode voltages of each stage.

The principal application of this amplifier has been in turntables. Providing other performance requirements are satisfactory, it is also economical to use this device where only one or two preamplifiers are required and the cost of a separate power supply is not warranted.

TYPE BA-3A PROGRAM AMPLIFIER

The Type BA-3A amplifier (Figure 14) is called the Program Amplifier, although the term is certainly not all-inclusive, since this is the most versatile amplifier in the line. The two stages of voltage amplification consist of two RCA-1620 tubes in cascade, working as pentodes and driving a single 1622 tube. A 5Y3 GT/G tube with an R-C filter comprises the power supply on the same chassis. Considerable feedback is employed from the tertiary winding of the output transformer to the cathode of the driver stage, to give the maximum output with the minimum distortion.



FIG. 13. Type BA-2A Booster Amplifier is a two-stage with self-contained power supply, low noise level and gain of 50 db.

The double volume control used in this amplifier is a rather unusual feature. It achieves reduction of noise level with the gain, and at the same time attenuates the input signal sufficiently to prevent overloading the first stage. One potentiometer is across the secondary of the input transformer, and another is in the grid circuit of the second stage. These two are combined in a dual pot to form a single gain control. The first section is used to control the input level. Its location makes possible operation on any level within the limitation of the input transformer, which is around $+15$ db (0.001 W. Ref.). The significant thing is that the input level may be varied over a range of about 75 db. The second section of the gain control actually changes the gain of the amplifier. The main justification for its existence, however, is in relation to noise level, for with the change of the control, the first stage is gradually cut out and its inherent noise level, therefore, is reduced. Proper tapers have been established for both sections of the potentiometer to give optimum performance. The input impedance is maintained at approximately source impedance over the audio frequency range.

The unbypassed cathode, in the first stage of course, automatically created a problem with noisy tubes. It was observed that in some cases, when alternate tubes such as the 6J7's were tested, a "bad" tube would show up—which increased the noise level of the amplifier up to 20 db. Apparently, the heater to cathode leakage is responsible for this adverse effect. To safeguard the amplifier, the potential gradient between the cathode and the heater was reduced by the application of a small amount of bias to the heaters. By this means, a uniform performance was obtained from the standpoint of noise level. The noise level, incidentally, with maximum gain is -57 db (0.001 W. Ref.) and with minimum gain is -66 db (0.001 W. Ref.). The maximum gain of the unit is 65 db. The frequency response is well within the limits of ± 1 db from 30 to 15,000 cps.

This unit has a 250-ohm input as well as the 600-ohm input. In addition to that a 20,000 ohm bridging input is provided. When the occasion arises for the use of bridging input, less gain is required; for that reason the resistive input is employed to

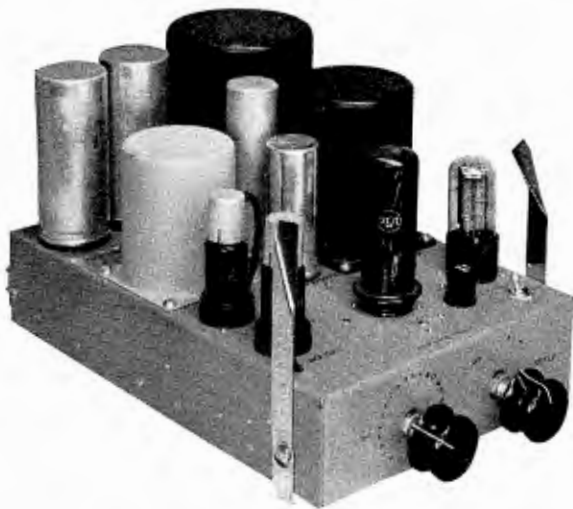

FIG. 14. Type BA-3A Program Amplifier is a versatile amplifier of wide usage, operable over extended ranges; gain, 65 db.

reduce the overall gain to 27 db, which is more than sufficient.

The output transformer is provided with taps at 600 ohms, 150 ohms, 15 ohms, 7.5 ohms, and 5 ohms. Aside from working into the telephone line, one or more monitor speakers may effectively be supplied from the low impedance taps. This amplifier can supply a total of 2 watts to several high-fidelity speakers, with a total distortion not exceeding 1% from 50 cps up.

This amplifier may be readily compensated at both the low and the high ends of the audio band to a maximum of 3 db. A switch is provided for metering the cathodes of all tubes at the standard value of 1 volt, indicating the proper plate current.

To summarize, the uses of this amplifier are as follows:

1. Program amplifier
2. Line amplifier
3. Bridging amplifier
4. High-level isolation amplifier
5. High-fidelity monitor amplifier
6. Driver amplifier (for high-power recording amplifiers, etc.).

TYPE BA-4A MONITORING AMPLIFIER

The Monitoring Amplifier, Type BA-4A (Figure 15) is a high-gain unit designed to operate from microphone levels and to deliver a high output. The tube complement consists of two RCA 1620, one 6SN7, two 1622, and a 5U4-G rectifier tubes. The first 1620 is operated as a triode which, through an inter-stage volume control, drives another 1620 operated as a pentode. The 6SN7 makes up the phase inverter stage which drives the 1622's in the push-pull output.

The maximum gain of this amplifier is 105 db, and the fidelity is within ± 2 db from 30 to 15,000 cps. The output of 12 watts is sufficient to drive several speakers or, in some applications, a recording head. Even at so high an output the distortion is less than 3% over the range of 50 to 15,000 cps.



FIG. 15. Type BA-4A Monitoring Amplifier is a high-fidelity, 12-watt amplifier for driving control room and audition speakers.



FIG. 16. Type BX-1A Power Supply is a low-noise, 250-volt d-c supply source particularly designed for use with BA-1A Preamplifiers.

The input may be operated from a 30 ohm source as well as a 250 ohm source, providing the level does not exceed -27 db (0.001 W. Ref.). The output transformer has taps at 600 ohm, 250 ohm, 15 ohm, 7.5 ohm, and a 5 ohm output, which makes this amplifier suitable for a number of applications. The noise level is -20 db. (0.001 W. Ref.) with the gain control maximum, and -40 db (0.001 W. Ref.) with the gain control minimum. The unit will operate on a line voltage varying from 105 to 125 volts. The power consumption is approximately 100 watts.

In recent years, a similar amplifier has been the most popular unit in the line. A great many of them have been sold for government orders with minor modifications to satisfy the special requirements for the particular application. One of the many uses

was for a line amplifier in conjunction with portable and mobile transmitters.

For some applications it is desirable to control this amplifier from a remote point. For this purpose a remote bridging volume control is supplied. A 10,000-ohm bridging is provided with a loss of 32 db in the overall gain. The response of this amplifier may be compensated, adding a boost of 5 db at 60 cps and 6 db at 10,000 cps.

TYPE BX-1A POWER SUPPLY

The BX-1A Power Supply Unit (Figure 16), mentioned previously, is a comparison unit to the plug-in amplifiers described in this article. It is the same size as a BA-3A Amplifier, has the same plug-in connectors, and matches in general appearance. It is primarily designed to be used as a source of plate voltage supply for BA-1A Preamplifiers and for this reason is provided with exceptional heavy filtering in order to make sure no hum or noise will be introduced in these low-level circuits. The BX-1A is carefully shielded so that it may, if necessary, be mounted on the same shelf as the preamplifiers (see Figure 18). All the other amplifiers described here have their own built-in power supplies and hence require no external source.

DIMENSIONS AND MOUNTING

All of the amplifier chassis are 11 $\frac{3}{4}$ inches long and 2 $\frac{1}{2}$ inches high with the exception of the narrow preamplifier chassis which is 1 $\frac{1}{2}$ inches high.

The widths of the chassis are very closely tied in with our new shelves. The narrowest unit is the preamplifier, which is 2 $\frac{7}{8}$ inches wide. A single shelf will carry six preamplifiers with $\frac{1}{4}$ -in clearance between them. (Figure 17.) The next size chassis, which is the most popular, is 7 $\frac{5}{8}$ inches wide; two of those chassis will fit on a shelf. (Figure 18.) The Type BA-3A, Type BA-2A, and the Type BX-1A are built on this size. The largest "plug-in" base available at this time is the Type BA-4A, which is 10 $\frac{1}{8}$ inches wide. One of these and two Type BA-1A preamplifiers will fit on a single shelf. (Figure 20.)

The units are laid out so that all tubes are accessible from the front. All of the chassis are made of steel from 0.050 to 0.093 thick, and have a baked, light umber-gray finish.

These amplifiers constitute a simple and extremely flexible system for a complete broadcast studio set-up. It is expected that, because of its many merits, this tried and tested development will establish a new trend.

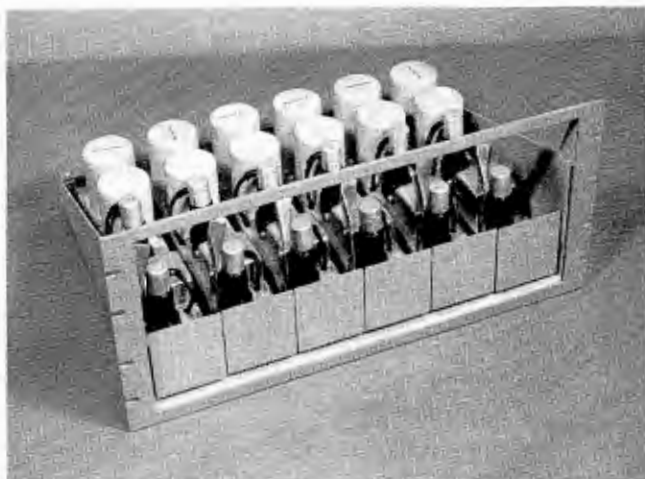

FIG. 17. Six Type BA-1A Preamplifiers on a BR-2A Shelf.

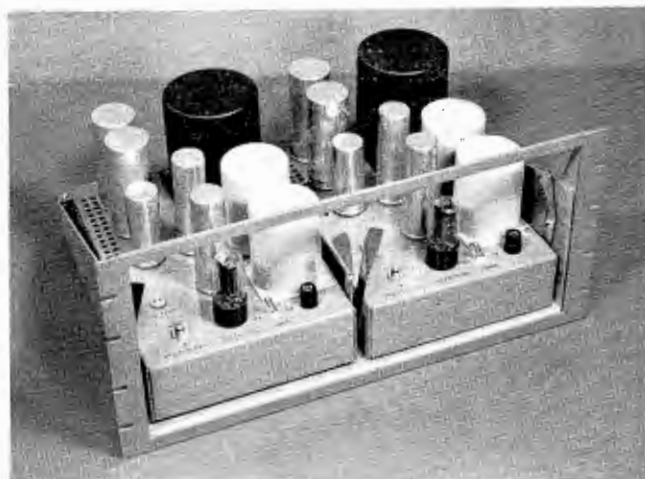

FIG. 18. Two Type BX-1A Power Supply Units on a BR-2A Shelf.

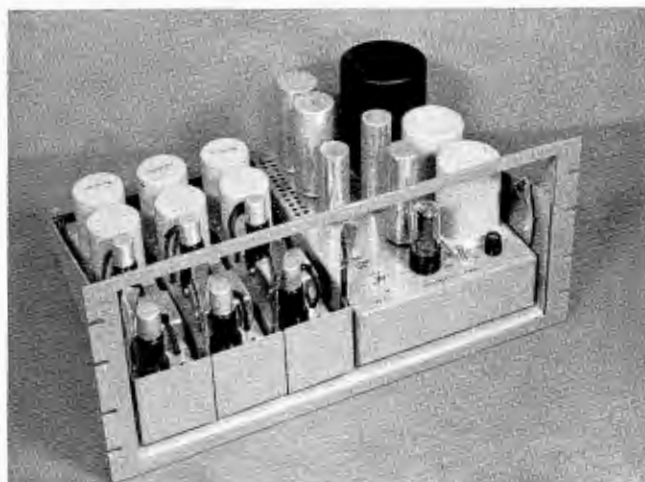

FIG. 19. Three BA-1A Preamplifiers and a BX-1A Unit on a BR-2A Shelf.



FIG. 20. Two BA-1A Preamplifiers and BA-4A Amplifier on BR-2A Shelf.

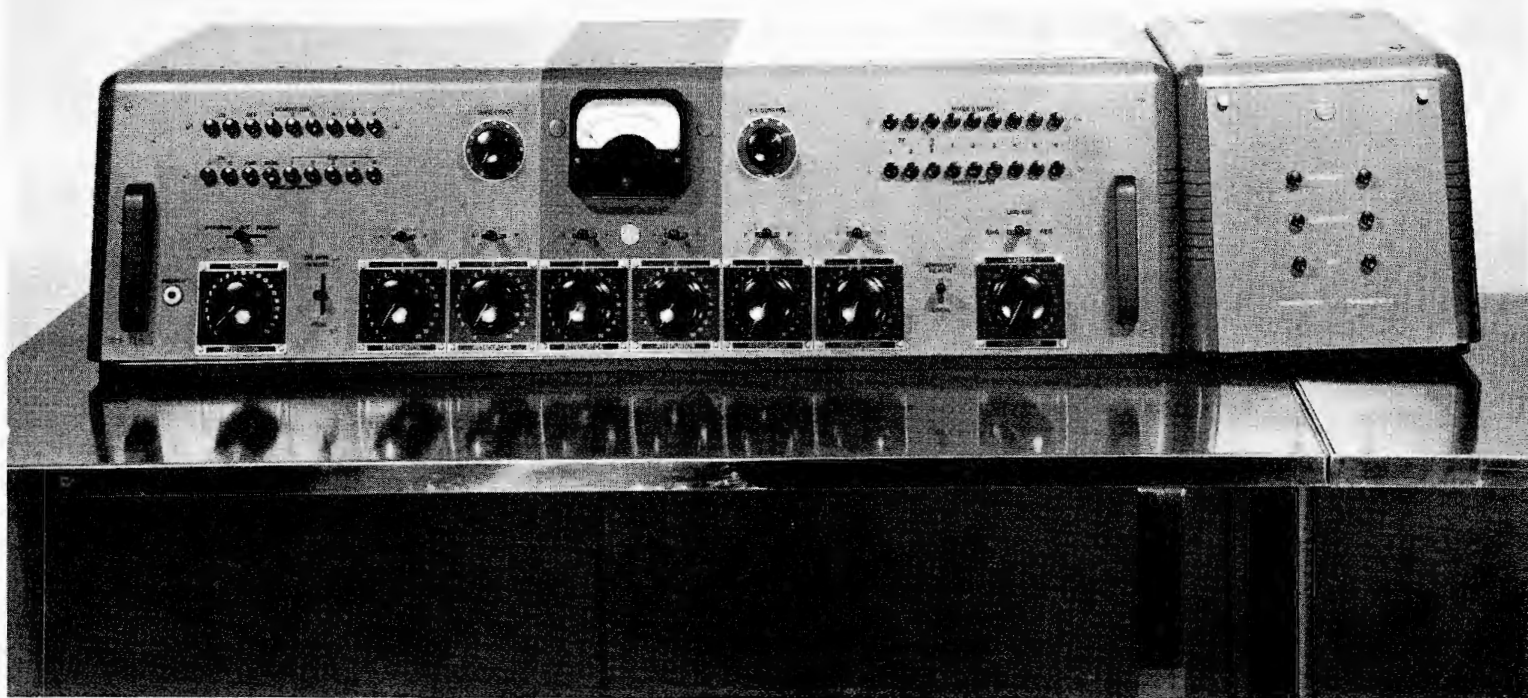

FIG. 1. The BCS-2A Switching Console (on right) with a standard 76-B4 Studio Console.

CONSOLETTA SWITCHING SYSTEMS

TYPE BCS-1A AND BCS-2A SWITCHING SYSTEMS GIVE MULTIPLE CONSOLETTA INSTALLATIONS FLEXIBILITY AND FACILITIES EQUAL TO THAT OF MANY CUSTOM INSTALLATIONS

by **DANA PRATT**
 Manager, Broadcast Equipment Sales

The addition of FM at many stations will require additional studio equipment to provide separate programming for the FM and AM transmitters. The Type BCS-1A and Type BCS-2A Switching Systems are intended to provide the switching functions between studios and transmitters for a wide range of operating requirements.

Long-range planning eliminates some of the temporary methods being used today. The operating procedure least demanding on the technical equipment is the one which completely duplicates the AM programs on the FM transmitter. This operating procedure is probably temporary.

A procedure which overtaxes both equipment and operator is the use of a single console to provide independent programs for the AM and the FM transmitters by the use of two program channels in a single console. This procedure has many limitations, which result in switching errors and program limitations. Most of this type of control equipment contains only two turntable positions. This limits record programming to either the AM or the FM transmitter. The equipment limitations can be corrected to provide two turntables for AM and two for FM. However, if a single operator has four turntables to keep going with split-second timing required for short fanfares, short spot-adds, theme music, etc., for two independent programs plus

watching for the cues from two announcers and riding gain for two VU meters, he would be like a juggler in a two-ring circus trying to perform in both rings at the same time. Two speakers blaring away with the separate AM and FM programs only adds to the confusion, with the result that many switching errors are made (such as putting a spot-add intended for AM on the FM transmitter and vice versa).

It is better operating practice to consider AM and FM programming as two separate operations with program mixing and monitoring in separate control rooms. The BCS-1A and BCS-2A Switching Systems are intended for this preferred operating procedure.

If only two studio controls are required, the RCA Type BCS-2A Switching Console will permit either studio control to feed either line or to feed both AM and FM lines. The RCA Type BCS-1A Switching System provides for the switching of as many as five studio controls into not more than three outgoing lines. Two of the outgoing lines would normally be the AM and FM transmitters and the third line may be considered as a utility channel for feeding network, recording room, auditions, etc. RCA custom-built equipment is available for requirements not handled by the stock switching systems.

(Continued on Page 53)

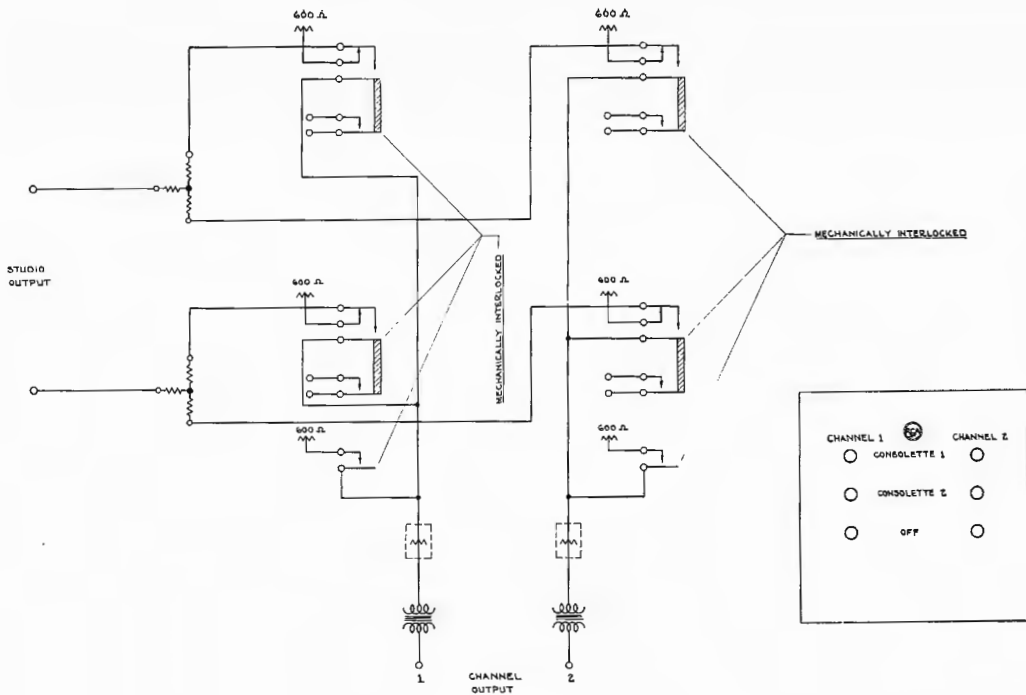

FIG. 2. Simplified schematic of the BCS-2A Console. Two studio inputs may be switched independently to either of two outgoing lines. Mechanical interlocking prevents feeding two inputs to the same outgoing line.

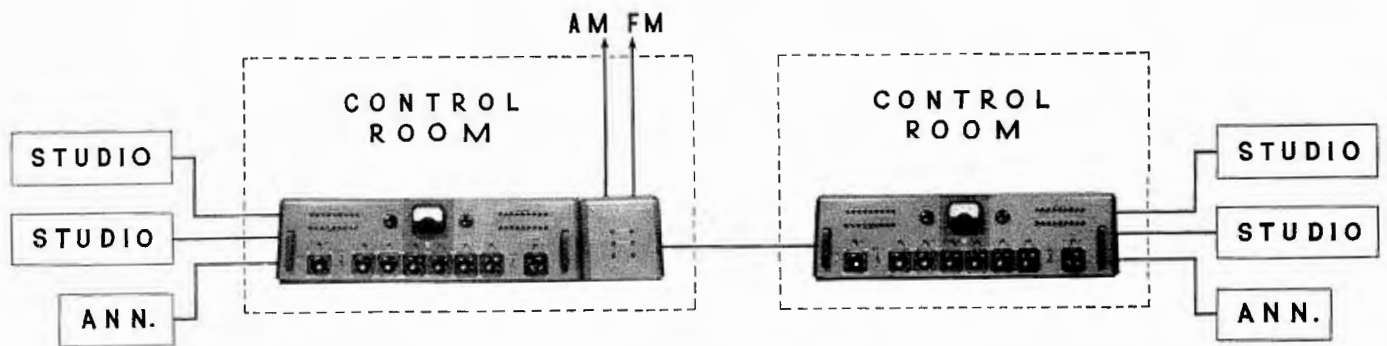

FIG. 3a. This diagram illustrates use of BCS-2A Console (located in the master control room) to switch output of master or auxiliary control room to either of two outgoing lines.

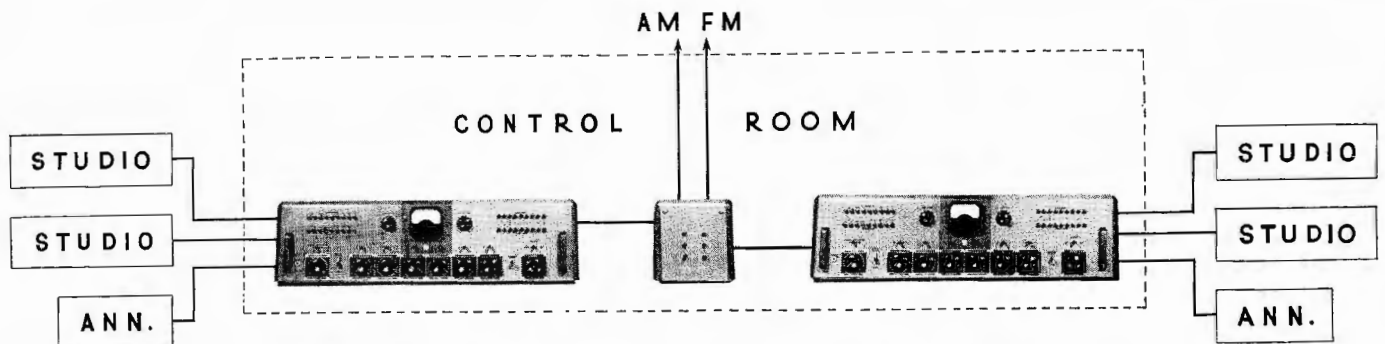

FIG. 3b. This is an alternative arrangement which may be used where both consolettes are located in a single control room. Consolettes may handle from one to three studios each.

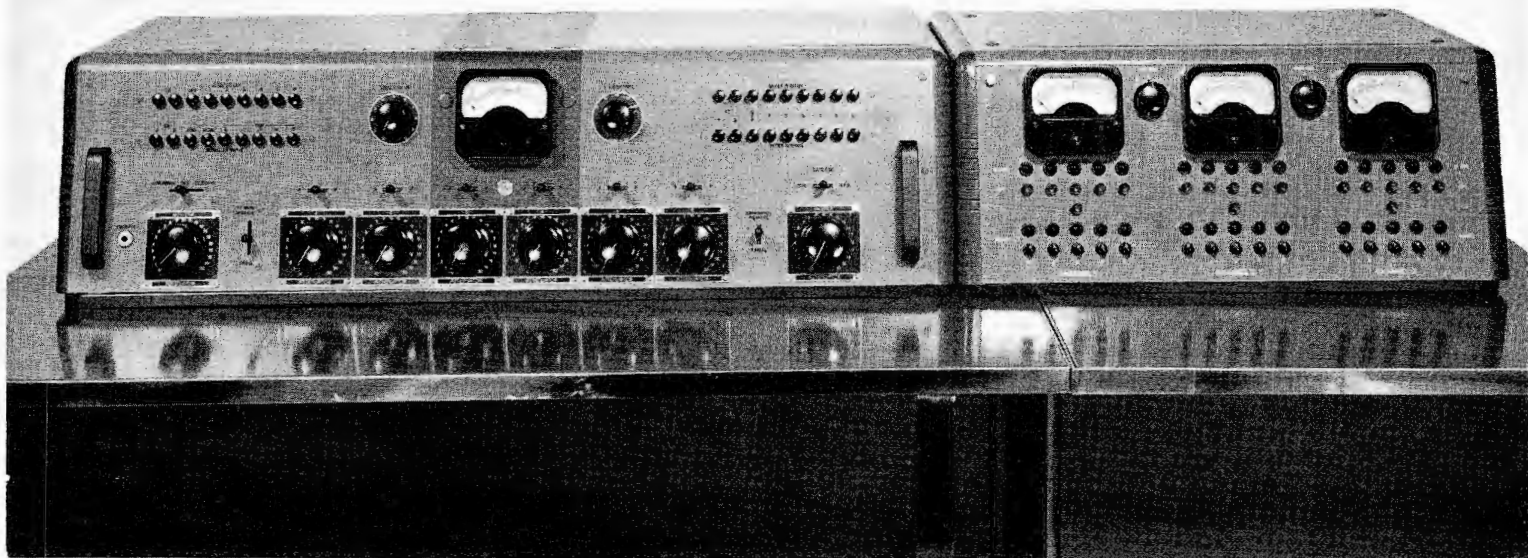

FIG. 4. The 76-B4 Console (left) with the BCS-1A Switching Console (right). This is a more elaborate unit capable of handling five incoming and three outgoing lines. The BCS-1A is a relay-operated system suitable for multiple control room layouts.

TYPE BCS-2A SWITCHING CONSOLE

The BCS-2A Switching Console uses mechanically interlocked switches for connecting two studio controls to two outgoing channels, such as AM and FM transmitters. Figure 1 shows the console located beside an RCA Type 76-B4 Console. Figure 2 is a simplified schematic of the circuit. If desired, either consolette can feed both transmitters or be switched to feed either transmitter. However, it is impossible to obtain the undesirable condition of both consolettes feeding the same line or transmitter. If program material is desired from two different studios for the same outgoing program, the consolette handling the program would obtain the supporting program material from another studio through the remote facilities of the consolette originating the program.

Switch contacts are available for signal light circuits. Holes covered by plug-buttons are provided on either side of the VU meter in the 76-B4 consolette so that signal lights may be added to indicate the outgoing lines being fed. This is a desirable feature since the switching console is located beside one of the 76-B4 Consolettes, and suitable confirmation of switching opera-

tions is required at the second consolette. Operators are not limited to two studios, but only to two control rooms or two consolettes. Each 76-B4 Consolette will handle two studios and an announce booth, which results in facilities for a maximum of four studios and two announce booths. See Figure 3 for typical layouts.

TYPE BCS-1A SWITCHING SYSTEM

The Type BCS-1A switching system is a relay operated system. The master switching console is usually installed in the principal control room. It contains all the relays required for the switching operations. The master switching console is shown installed beside a Type 76-B4 Console in Figure 4 and a sub-control unit is shown in Figure 5. Both units are styled to match the Type 76-B4 Consolette and access to the switches and relays is obtained by lifting the front and top portions of the case which are hinged at the back the same as the 76-B4 Consolette.

The complete system will switch the output of five studio controls to three outgoing lines. However, many combinations of reduced facilities can be used. If the occasion should require a

FIG. 5. The 76-B4 Console (left) with a BCS-1A Sub-control Console. In this system one such unit is located in each control room. "Ready" switches on the master unit allow switching function to be performed at the sub-control unit when desirable



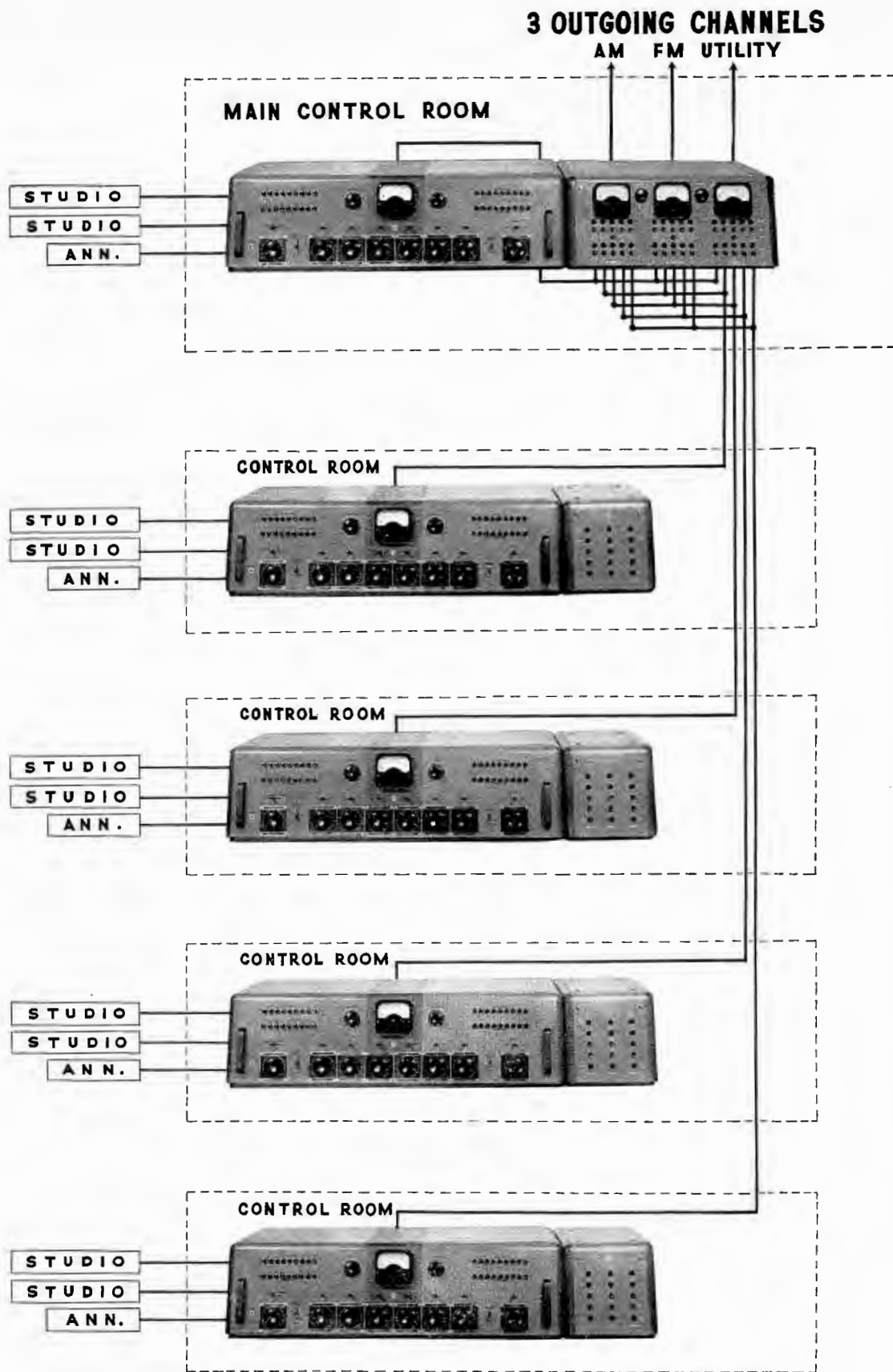

FIG. 6. Arrangement of Consolettes, Master Console and Sub-control consoles in a multiple-control room installation using the BCS-1A Switching System. Such an arrangement provides flexibility and operating convenience approaching that of a "custom" layout. Up to five sub-control rooms may be employed, each of which may handle from one to three studios.

switching console only in a single control room from which a number of studios are monitored, the master control console can be used as a unit. Another application is to use the master switching console in a master control room and the sub-control consoles in the individual control rooms. There can be a maximum of five individual control rooms.

An important use of the BCS-1A Switching System is its application as a "roving" switching system. This feature permits the reduction of operating personnel by eliminating the need for a master control operator. In these applications the master switching console would be located in the principal control room so that this operator, who would normally be on duty at all times, could assign switching functions to any of the control rooms by means of the ready switches located on the master control console. Refer to Figure 6 for a typical layout.

Many various inputs can be used since they need not be studios, but may be network, recording room, or frequent remotes; if they are important enough to justify an input position. Likewise, the outgoing channels may be a wide variety of combinations including AM and FM transmitters, recording room, network feed, audition, etc.

Reference is made to the master switching console in Figure 7. There are three groups of switches and an associated output VU meter for each of the three outgoing lines. In each group the top row is a series of lights that indicate which of the five studio controls is feeding the outgoing channel. Studio "ON" switches are located below the lights. A single studio release switch for each channel is on the next lower level. Ready lights and ready switches are on the two lower rows. On the left side of the center VU meter is a ten-position monitor selector switch for monitoring outgoing lines, other studios, network, etc. The control to the right of the center VU meter is a monitor volume control for an 82-C or BA-4A Monitoring Amplifier.

The sub-control units, Figure 8, have three vertical rows of lights and switches. Each vertical row is associated with an outgoing line. Reading from top to bottom, the horizontal rows are the "ON AIR" lights which light only in the program originating control rooms and indicate which outgoing line or lines the original control room is feeding. The next row is "IN USE" lights. These lights are operated when the originating studio, or any other studio, is feeding program to the channel. The "ON" and "OFF" switches and the ready lights are the bottom three rows.

The master switching console can put any studio on the air or take it off the air at any time. It also has within its control

the assignment of these functions to a sub-control room by the operation of the ready circuit switches located on the master switching console. A sub-control unit is inoperative without the master switching unit having completed the ready circuit for that studio and on the channels for which it is desired to permit the sub-control unit to make switching functions. This precaution and assignment of responsibilities is necessary so that inadvertent operation of switches in a "dead" control room would not cause unscheduled switching functions. The ready circuit also serves another function, since it is an indication to both the master control operator and to the sub-control operator of the channel or channels on which the originating control room is to be connected at the next designated switching period. Normally, the master control operator has fifteen minutes or more to review his studio operating schedule and set up the switching functions for the next switching period. At the time of the switching period the sub-control operator operates his "ON" button associated with the ready light as soon as the channel "IN USE" light is extinguished. The system is designed to permit a single studio to feed as many as three outgoing lines, but will not permit more than one studio to be on the same outgoing line. This is obviously necessary to avoid uncoordinated control rooms putting separate programs on a single outgoing line. Should more than one studio be required for a single program, the supporting studio would be handled as a remote by the originating studio.



FIG. 8. (Above) Closeup of Sub-control Console. Controls in each vertical row (from top to bottom) are: "On air" light, "In use" light, "On" push-button, "Off" push-button, "Ready" light.

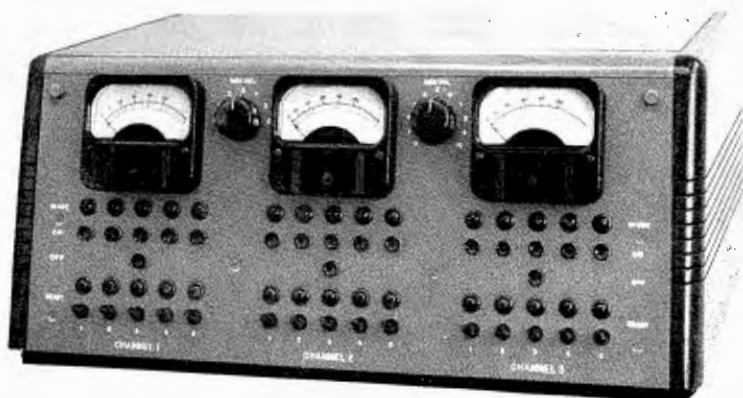

FIG. 7. (Left) Closeup of Master Console. Controls under each meter (from top to bottom) are: five "In use" lights, five "On" push-buttons, one "Off" push-button, five "Ready" lights, and five "Ready" switches.

TYPE BTF-10B

10 KW FM TRANSMITTER

by J. E. YOUNG
Engineering Products Department

Continuing the trend set by RCA in the popular lower power FM transmitters, RCA engineers have designed a 10 KW FM transmitter which contains many features attractive to the station engineer faced with the problem of the selection of this type of equipment. RCA's "building block" plan has been extended to include this new power level, so that it is now possible to add the 10 KW transmitter units on to any of the standard RCA FM transmitters with a minimum of lost time and leftover equipment.

The appearance of the transmitter illustrated in Figure 1 carries on the smooth attractive styling familiar to everyone who has seen RCA broadcast transmitters, of either the AM or FM type. Unit-frame construction is used, and the frames, meter panels, doors, and side shields are of the same standard construction and appearance as those used in the lower power FM transmitters. Five frames, each provided with front and rear full-length access doors and mounted on a common base, are used. The overall length of the transmitter is $131\frac{3}{8}$ inches. A generous number of meters and status lights are provided, all mounted on the meter panel which runs across the full length of the transmitter. All meters have black scales and white figures for easy reading from any point in the operating room.

The center cabinet contains the frequency-modulated exciter. This is the basic unit of all the FM transmitters and, like the BTF-3B, provides additional space in which a spare exciter, its power supply, and a switching panel, may be mounted. If these additional units are used it is possible to switch to the spare exciter in an instant, since the transfer of the audio input connections and the r-f output is effected by a single front-of-panel switch. A separate power control switch is provided for each exciter to allow for preliminary warm-up.

The radio-frequency amplifiers are located in the cabinets to the left of the center. The cabinet next to the exciter is identical to the r-f cabinet provided in the BTF-3B. It contains the Type 4D21 doubler, the two Type 4D21's connected in parallel (constituting the 250-watt amplifier), and the two Type 7C24's mounted in their unit-assembly tanks. These are connected in cascade to provide a generous 3 KW driving power for the 10 KW amplifier. On the front panel of this unit, accessible whether the front door is open or shut, are located the tuning controls for each of these stages. The controls for the doubler and 250-watt amplifier are cranks, provided with turn-counter dials, while the controls for the 1 KW and 3 KW amplifiers are convenient lever-type switches. The tuning and loading of each of these stages is adjustable for any condition of operation at any frequency in the FM band by means of these controls. There are no other taps or links to be set or adjusted.

The 10 KW amplifier is housed in the lefthand end cabinet. A single Type 9C26 air-cooled tube is used in a grounded-grid circuit. The electrical circuit is the same as that used in the grounded-grid 1 KW and 3 KW amplifier stages and, like these amplifiers, tuned, transmission-line type circuits are employed. Since the grid is grounded for radio-frequency voltages, the driving voltage is applied between ground and filament. A three-quarter wave line is used in this circuit, tuned by means of a motor-driven variable capacitor. The output of the driver stage is coupled to this circuit by a small coupling loop, fed from a concentric transmission line. The plate tank is concentric with the anode of the tube and its air-cooler, forming the upper end of the inner conductor of the transmission line. The outer conductor of this line is square in cross section and is arranged so it may be easily disassembled to permit inspection or service. Tuning is accomplished by adjusting the position of a capacitor-type shorting bar, by means of motor-driven screws. Output coupling is effected by a small loop properly oriented in the space between the inner and outer conductors of the plate line. Power output, like input and plate circuit tuning, is controlled from the front panel through a tuning switch and motor. Cooling air for the 9C26 is provided by a quiet blower equipped with intake filters and mounted behind the power amplifier cabinet. The cooling air is carried into the base of the power amplifier by a duct, thence up through the inside of the center conductor of the plate line to the tube. It is exhausted out the top of the cabinet and may be carried outside through a duct or exhausted into the room, as desired.

The two righthand cabinets house the power supply and power-control gear. In the first cabinet, to the right of the center, are mounted the six Type 8008 rectifier tubes which provide high-voltage direct current for all amplifiers (except those integral with the FM exciter). Also contained in this cabinet are

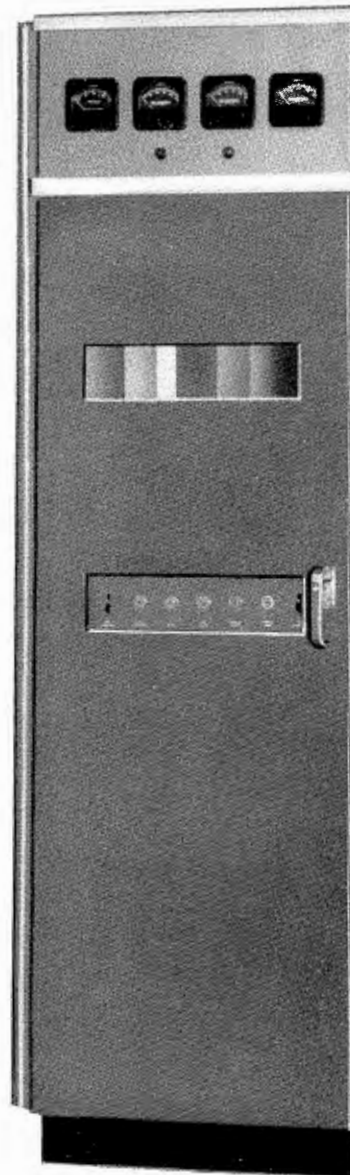



FIG. 1. RCA BTF-10B Transmitter

the elements of the filters used to insure low-carrier noise level. The plate transformer is air-cooled, and is designed to be conveniently mounted external to the transmitter. It is self-enclosed, and is provided with a delta-wye switch to permit low-voltage operation for tune-up and test.

The power control cabinet contains the control circuit relays, overload relays, and timers required to assure correct sequential starting and full protection for all of the transmitter circuits. Some of the features worthy of especial note are: the individual overload protection for the amplifier tubes; automatic starting; automatic reclosure and lock-out; no-delay return to the air after momentary power drop-outs; and target-type indicators on overload relays. Full mechanical and electrical interlocking is provided in all cabinets where dangerous voltages may be encountered.

The transmitter is designed to operate on a 208/230-volt, 3-phase, 60-cycle power line. The power consumption is approx-

imately 25 kilowatts, and the power factor better than 85 per cent. Equipment for operation on 50-cycle power is available at a slight additional cost.

Since transmitter locations at rather high altitudes are to be expected, a sufficient safety factor in voltage insulation and cooling-air capacity has been provided to permit trouble-free operation at altitudes to 5000 feet above sea level.

Additional equipment provided with the transmitters, but not mounted within the enclosures, include: an audio, pre-emphasis network (provided as a separate item so that it may be connected into the audio line ahead of the line-terminating amplifier if desired); a harmonic filter, arranged to mount conveniently on wall or ceiling and connect in the transmission line between the transmitter and antenna; and a protective device, which mounts alongside the harmonic filter and continuously checks the standing-wave amplitude of the transmission line. Both of these latter devices are important to continuous, trouble-free op-

eration of the station. The harmonic filter, by greatly attenuating all frequencies above the fundamental, insures that other services, operating on higher frequencies, will experience no interference—even though located close to the transmitter. The standing-wave detector monitors the operation of the antenna and transmission line and will cut off the carrier if a sudden change in the standing-wave ratio, such as would result from a transmission line or antenna element arc over, should occur. Through the reclosure relay, power will be reapplied immediately and, if the fault has cleared, normal operation will continue.

The BTF-10B has been engineered so that the problems of installation peculiar to FM transmitters are greatly simplified. The transmitter breaks down into five separate units, each small enough to be easily handled even in the restricted spaces and openings found in the upper stories of tall buildings. Figure 3 shows a typical transmitter layout. The amount of space required and the necessary interconnections have been reduced to a minimum. Interconnection has been further simplified by providing a wiring channel in the rear of the base of the transmitter. This may be tied into floor channels to make all wiring installation and servicing extremely simple. The fact that only the power-amplifier blower and the main plate transformer are mounted external to the transmitter enclosure further simplifies the installation.

Since the BTF-10B has been designed as part of a complete line of transmitters, unusual care has been used to make provision to increase the power of the smaller transmitters. This is done by adding on the 10 KW amplifier, and by arranging the 10 KW transmitter so that the 50 KW amplifier can be added to it. The result is a line of transmitters permitting wide flexibility in the choice of power and providing for the ready increase in power at minimum expense, should it prove necessary.

Circuits and components have been engineered so that the equipment is actually easier to adjust and service than transmitters of comparable power used for AM broadcasting. The result is an engineer's transmitter of such economy and reliability that it will be equally attractive to the station manager.

PERFORMANCE SPECIFICATIONS

Frequency Range.....	Any specified frequency between 88 and 108 mc
Power Output (into transmission line)....	3,000 to 10,000 watts
R-F Output Impedance.....	35 to 75 ohms
Carrier Frequency Stability.....	Deviation less than 2,000 cycles
Modulation Capability	± 100 kc
Audio Input Impedance.....	150/600 ohms
Avg. Program Level.....	$+4 \pm 2$ vu.
100% Modulation Level.....	$+10 \pm 2$ dbm
Audio Frequency Response (30 to 15,000 cycles, 1,000 cycle reference) uniform within.....	± 1 db
Audio Frequency Distortion (30 to 15,000 cycles, including all harmonics up to 30 kc/s at ± 75 kc swing)	Less than 1.5% rms
FM Noise Level, below ± 75 kc swing.....	.65 db
AM Noise Level, below 100% Amplitude Modulation.....	.50 db
Power Line Requirement—Transmitter	
Line Voltage.....	208/230 volts
Frequency	50 or 60 cycles
Power Consumption (approximate).....	25 kw
Power Line Requirements—Crystal Heaters	
Line Voltage.....	115 volts
Frequency	50/60 cycles
Power Consumption.....	.28 watts

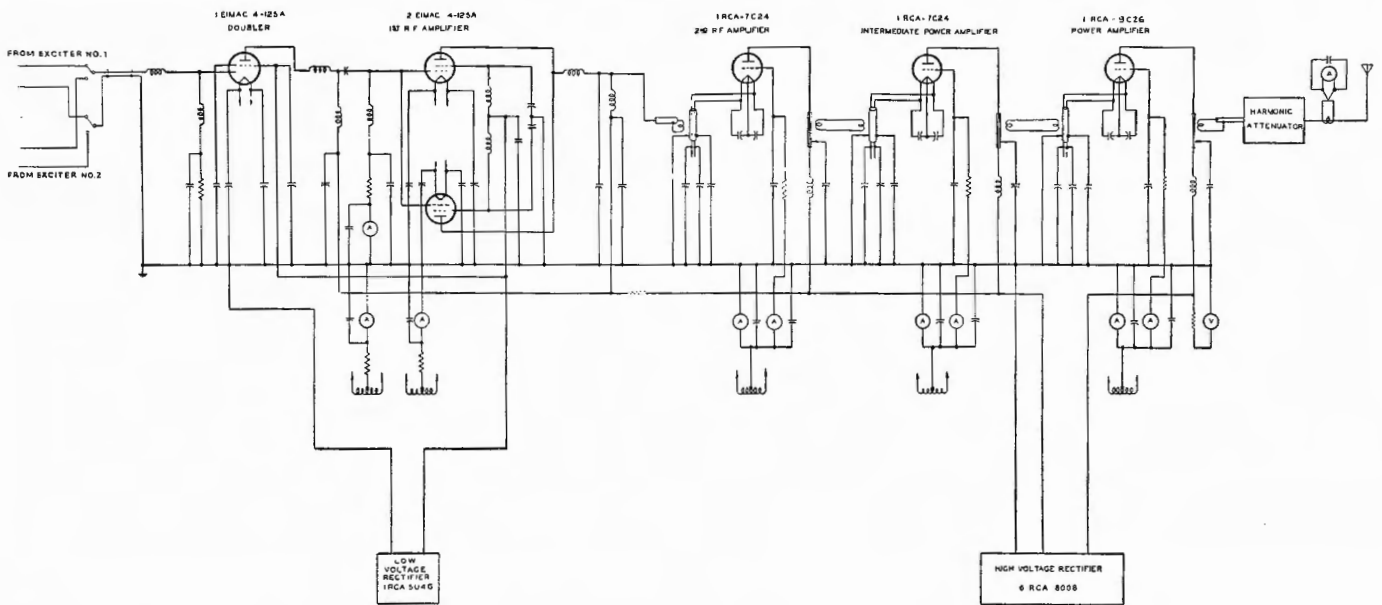
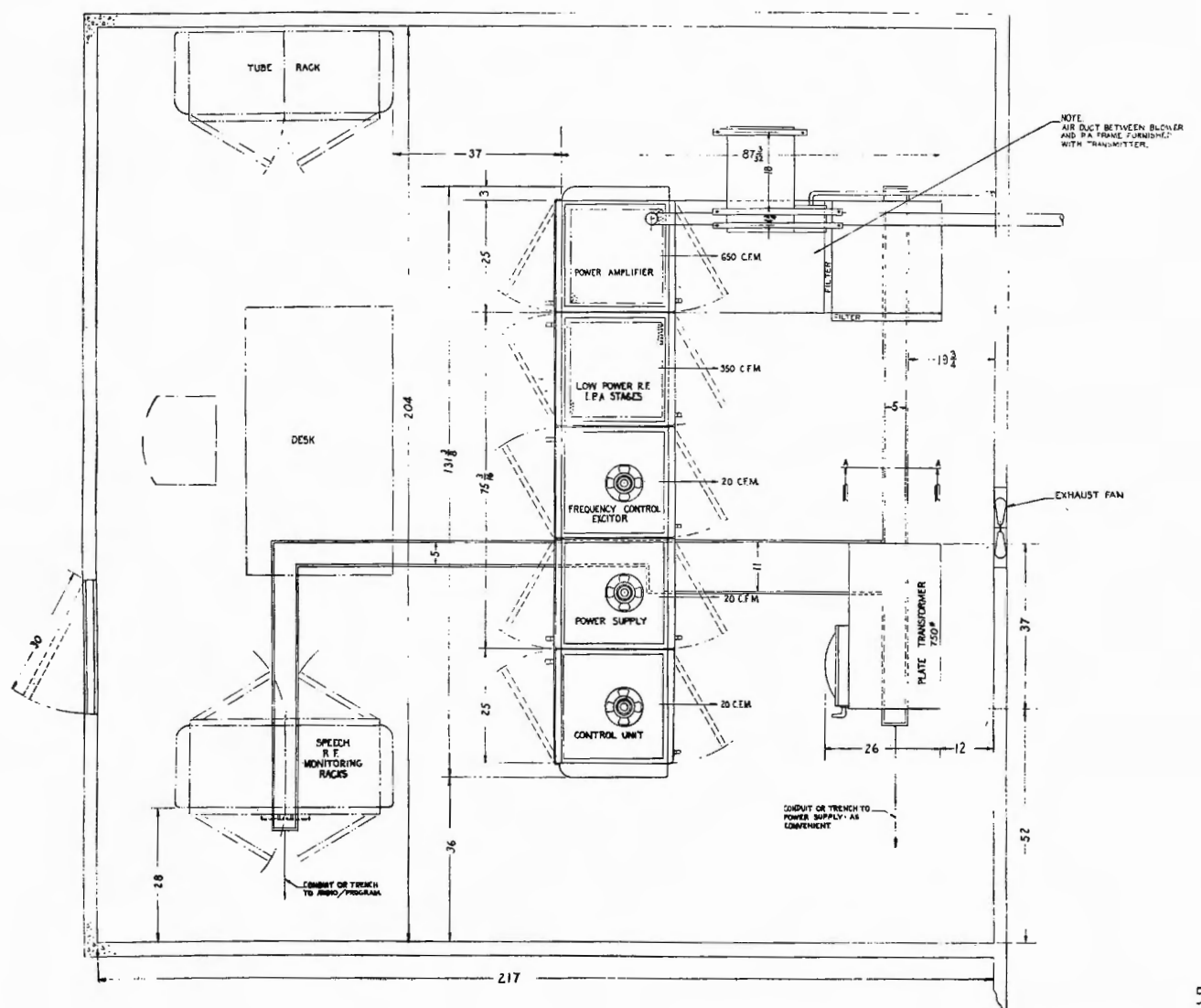
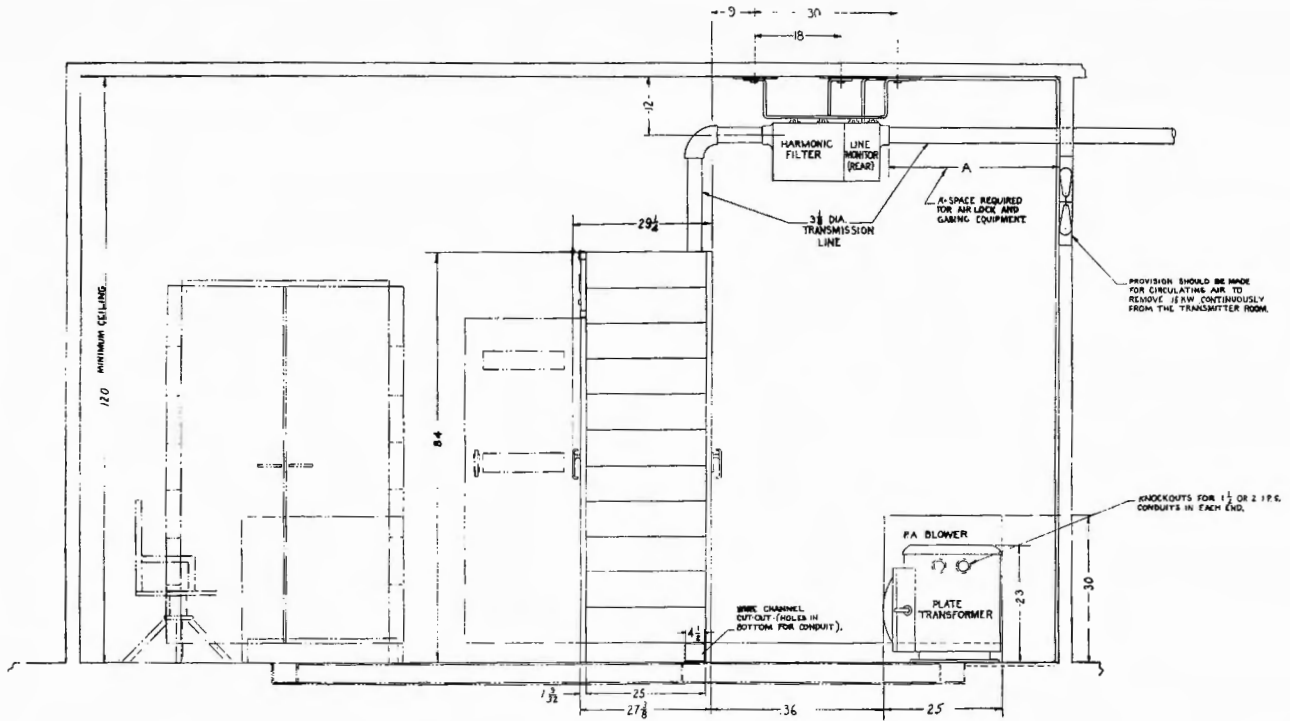

FIG. 2. (Above) Simplified schematic diagram of the RCA BTF-10B Transmitter, Schematic of the exciter was shown in BROADCAST NEWS No. 42 (January 1946) on Page 29.

FIG. 3. (Opposite Page) Side elevation (upper) and floor plan (lower) of a suggested room arrangement for the BTF-10B Transmitter which is shown on the preceding page.



TYPE BTF-50A

50 KW FM TRANSMITTER

by C. J. STARNER

Engineering Products Department

The BTF-50 transmitter is a 50 kilowatt FM Broadcast Transmitter tailored to the particular requirements of frequency-modulation service, while retaining all the features that experience has built into RCA standard-band transmitters. It may truly be called a "companion piece" to the BTA-50F transmitter, incorporating as it does many of the electrical and physical features of the standard-band transmitter. Features include a unified front, stream-line styling, centralized power and control units, motor-driven tuning elements, air-cooled vacuum tubes, and emergency cut-back. Features of interest to the user planning installation in an existing building are its compactness, ease of installation, small size of individual units and easy adaptability to space requirements.

A plan view of a typical layout of the BTF-50A is shown in Figure 1. The front panel is 84 inches high and 16½ feet long. The r-f section of the transmitter is placed behind this panel with the exciter to the right and the 10 KW amplifier to the left. The 50 KW amplifier is built as one unit, comprising the intermediate amplifier and the final amplifier, which is set back from the front panel to provide a walk-way for inspection, tube changing, etc. Provision is made to store a spare tube and to receive a defective tube back of the front panel at the end of the 50 KW amplifier unit. Tube changing is facilitated by providing an overhead hoist to lift the tube and by use of quick acting tube connections. A non-interlocked door provides free access to the 50 KW amplifier at all times, since its units are entirely enclosed and protected by interlocks.

The right hand panel section contains the low power r-f stage, and the 10 KW blower. Tuning controls for the low power stages are located at their respective units, as are the indicating instruments for these stages. Tuning controls for the 50 KW amplifier are centralized on the center section of the front panel, together with indicating instruments associated with these controls. Normal operational controls are also located in this same central position. Indicator lamps, showing operation of overload relays are located on the front panel, as is a control switch for transferring from normal 50 KW operation to emergency operation at approximately 8 KW output.

Ease of installation is a feature of this transmitter. Top of building location has been kept in mind and unit sizes held to a minimum. Where a unit was considered too large for convenient handling and passage through building opening, it was designed for easy breakdown into smaller units, with a minimum of effort. The maximum unit size established by inquiry in the field and based on average elevator sizes and wall openings, is 30 inches by 50 inches by 80 inches. Any unit larger than this is assembled in separate frames and bolted together. All wiring between sub-units is so arranged that dis-assembly becomes a matter of removing wire jumpers and removing frame bolts.

Installation flexibility is attained by making the r-f section an integral unit, with interconnecting wire ducts provided, and considering the power equipment as items which may be strategically placed to avoid building obstructions, and to utilize existing space with minimum of alterations. The minimum required "one piece" (back of panel) is 9 by 19½ feet, and power equipment may be located as desired, either on the same floor level or in basement space. Power equipment is constructed in units entirely enclosed and interlocked so that no fences or enclosures are required. Interconnecting conduit and wire ducts are held to a minimum, by enclosing all switch gear and control in one cubicle and by enclosing all d-c power in one unit.

The intermediate and final power-amplifier unit consists of two air-cooled triodes operating in parallel, driven by a third tube of the same type, both stages being grounded-grid amplifiers. The final and intermediate-power amplifiers are essentially alike, using concentric lines for input and output circuits, with the input or cathode line being folded down over the output or plate line. The two units making up the final amplifiers have their input circuits excited in parallel with their outputs feeding into the output transmission line. Individual motors drive the tuning elements, but are operated from one control so arranged that in conjunction with an auxiliary switch any pair of tuning motors can be operated (either in the same or opposite directions), thus giving differential tuning adjustment for balance of loading, etc. To prevent unintentional tuning, a neutral position on the auxiliary switch makes all tuning control inoperative. Each amplifier is completely shielded to prevent radiation and all control wiring is kept out of r-f fields. Since the final amplifier consists of two amplifiers feeding a common load, it is possible to supply the load from one of the amplifiers at reduced power. Hence for power below 25 KW (F.C.C. requirements call for power outputs from 10 KW to 50 KW) one amplifier only may be used either by physically removing the tube, or by de-energizing the filament. In this way there is subsequent saving in tube costs and filament power. For the low-power r-f stages units of the lower powered transmitters are used, with control integrated with that of the BTF-50A and with plate power supplied by the main rectifier. The low power air supply is independent of the main blower for emergency operation. These units are the r-f section of the RCA BTF-10B transmitter, described elsewhere in this issue, with the exciter unit in the center, the 3-kilowatt stages to the right, and the 10-kilowatt stage to the left.

For the main rectifier, six RCA 857-B mercury-vapor tubes are connected in a three-phase, full-wave circuit with a half-voltage tap to supply the lower power stages. A pre-heated spare tube can be manually switched in place of any of the six operating tubes, at the same time removing the defective tube

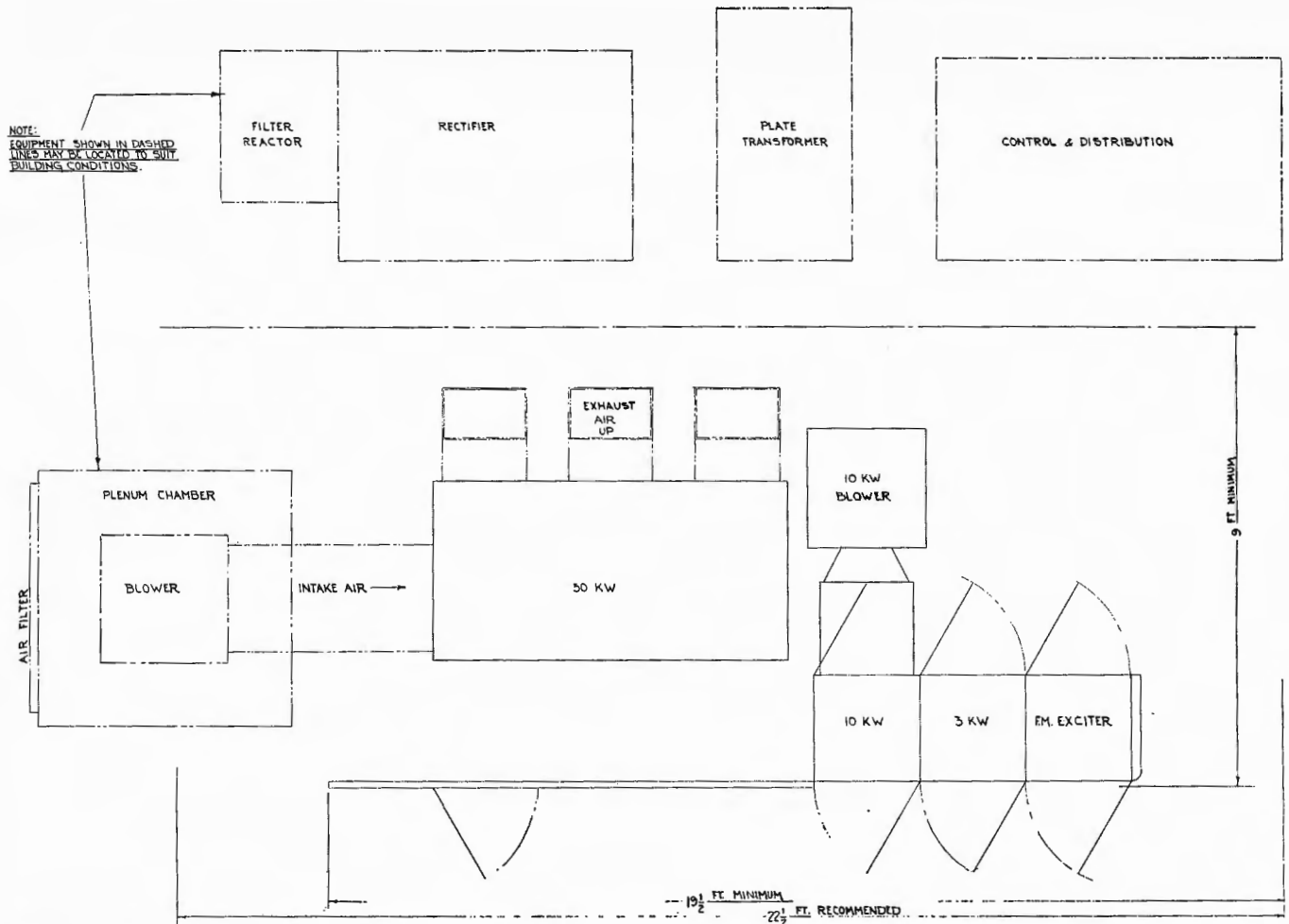

FIG. 1. Suggested floor layout for the BTF-50A Transmitter. The various component units may be arranged to suit the space available (see text).

from the circuit. The a-c input from the plate transformers is brought in through a duct in the side, and the d-c output goes to the r-f sections in an overhead duct. The plate transformer is a three-phase air-cooled unit, totally enclosed and located between the switch-gear cubicles and the rectifier with interconnections in overhead ducts. Extended primary windings give lower plate voltage for test purposes. The rectifier is a completely enclosed unit and is protected by automatic interlock switches. Only one other rectifier is used (excluding the exciter regulated power supply), and this is a small unit located in the low power r-f section to supply screen voltage to low-power tubes.

All control and distribution items are mounted in an enclosed cubicle, as well as an induction regulator, to hold filament voltages to close limits, filament starting reactors, and distribution transformers. Protection against faults is carefully planned and is based on standard-band 50-kilowatt experience. The use of one rectifier to supply all anode voltages leads to simplified control circuits requiring a minimum of components and consequently a minimum of maintenance. Overcurrent relays in the cathode lead of each high power tube provide protection in case of gas arcs, and an overcurrent relay in the rectifier return provides protection in case of a d-c arc to ground. Overcurrent line relays protect in case of rectifier arc backs. Overload relay

operation is shown by front-panel indicator lamps to aid in localizing faults. A reclosing relay gives three reapplications of plate power after overload operation, with lengthening time intervals after each reapplication, and locks out after the third reapplication until manually reset.

Standard-power switchgear cubicles are used. Draw-out hum-free mechanical-latch type high-speed air-circuit breakers are employed for all high-power circuits. Overload protection consists of a selective relaying system combining high-speed tripping on d-c overloads and short-circuit faults with time-delay tripping on nominal a-c system overcurrent and under-voltage faults. Switching in the plate transformer primary is provided for test voltages.

Emergency operation at approximately 10 kilowatts is provided. A control switch automatically shuts off plate power, disconnects the intermediate and power amplifiers, grounds their d-c feed, transfers the antenna from the final amplifier to the last stage in the low-power r-f section, and then reapplies plate power. At the same time it by-passes all interlock switches on the intermediate and final amplifiers, allowing their air and filament power to be removed. The final and intermediate amplifiers and the blower supplying their air are thus isolated and

tube changing and servicing may be done while operating at reduced transmitter output. The antenna switching is accomplished by special transmission-line switches of trouble-free latch-trip design.

A carrier monitor is provided which acts as a "watch dog" over the antenna and transmission line. Any unwarranted change in signal intensity, such as might result from an arc in the transmission line or a fault in the antenna itself, actuates this monitor which shuts down the transmitter. The reclosing mechanism will then return the transmitter to the air if the fault has cleared, and if the fault still persists, will do so three times and then lock out. A harmonic attenuator is provided to insure the suppression of harmonic radiation. This is a self-contained unit, being a pre-tuned low pass filter, using line elements, and being capable of approximately 38 db attenuation of harmonics. Use of generous size line elements assures low insertion loss and high attenuation.

Essential operational controls and indicator lamps are duplicated on a supervisory console, designed to be set up in a convenient position in front of the transmitter. Controls for program handling are provided as well as a VU meter and extension modulation monitor meters.

A summary of performance specifications of the BTF-50A transmitter is listed below:

- (a) Type of emission.....A3
- (b) Frequency range.....Any specified frequency between 88 and 104 mc
- (c) Power output (into transmission line) 10,000 to 50,000 watts
- (d) R-F output impedance.....35 to 75 ohms
- (e) Carrier frequency stability, deviation..Less than 2000 cycles

- (f) Modulation capability.....±100 kc
- (g) Method of modulationReactance-tubes
- (h) Audio input-impedance.....600 ohms
Avg. program level.....+4 ±2 VU
100% modulation level.....+12 ±2 dbm
- (i) Audio frequency response*
30 to 15,000 cycles
1000-cycle reference, within.....±1 db
- (j) Audio frequency distortion**
30-100 cycles1.5%
100-7500 cycles1.0%
7500-15,000 cycles1.5%
including all harmonics up to 30 kc/s at 75 kc swing
- (k) FM noise level, below ±75 kc swing**.....65 db
- (l) AM noise level, below 100% amplitude modulation** 50 db
- (m) Power line requirement-transmitter
Line voltage440-480 volts
Phase3
Frequency60 cycles
(Can be adapted for 50 cycles with minor modifications)
Total variation including regulation.....5%
Power consumption (approximate).....120,000 watts
Power factor87%
- (n) Power line requirements—crystal heaters
Line voltage.....115 volts
Phase1
Frequency50/60 cycles
Power consumption28 watts

* For pre-emphasized response the pre-emphasis filter (MI-4926A) is provided to be inserted in the 600-ohm audio input line at the most effective point.

** Distortion and noise is measured following a standard de-emphasis network.



"Wrong again neighbor—it isn't my radio and I can't shut it off."

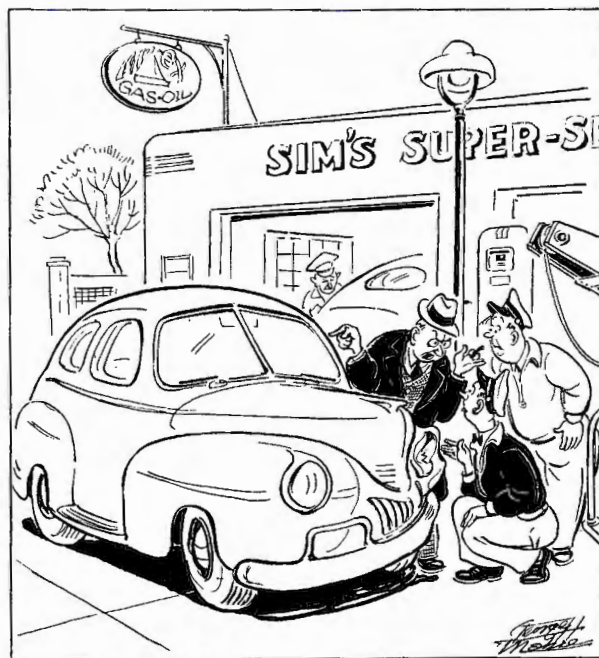

"... and fix the radio so my wife can't get Frank Sinatra while she's driving."

DETERMINING THE POPULATION SERVED BY AN FM STATION



**Method of using Minor Civil Division Maps and Population
Bulletins in determining population within
practical service area**

**TABLE NO. 1. DISTANCE TO 1 MILLIVOLT
AND 50 MICROVOLT CONTOURS**

<i>Direction of radial</i>	<i>Distance to 1 millivolt contour</i>	<i>Distance to 50 microvolt contour</i>
N	18	47
NE	18	47
E	18.5	51
SE	19	52
S	19	52
SW	19	52
W	19	52
NW	19	51.5

In order to answer the questions in paragraph 30(c) of Application Form No. 319 for an FM Construction Permit, it is necessary to determine the population residing within the proposed one millivolt and 50-microvolt contours. The procedure for making this "population count" is the same as that which has been more or less standardized in AM station allocation practice.

The first step is to plot the station coverage on a "Minor Civil Divisions" Map of the state (or states) in which the area is located. Minor Civil Divisions maps show the boundaries of the wards, precincts, or other minor divisions into which the counties or parishes of the state are divided. Such divisions are of interest because the population breakdown as given in the Population Bulletins of the Census Bureau is listed by such divisions.

The data on coverage, which should be calculated as described in Section ZE of the FCC Standards, gives the distances to the 1-millivolt-per-meter and 50-microvolt-per-meter contours in eight directions—usually along radials spaced 45° apart around the circle. This data for the case of WBRL (which has been used as an example throughout) is shown in Table 1. In using this data,



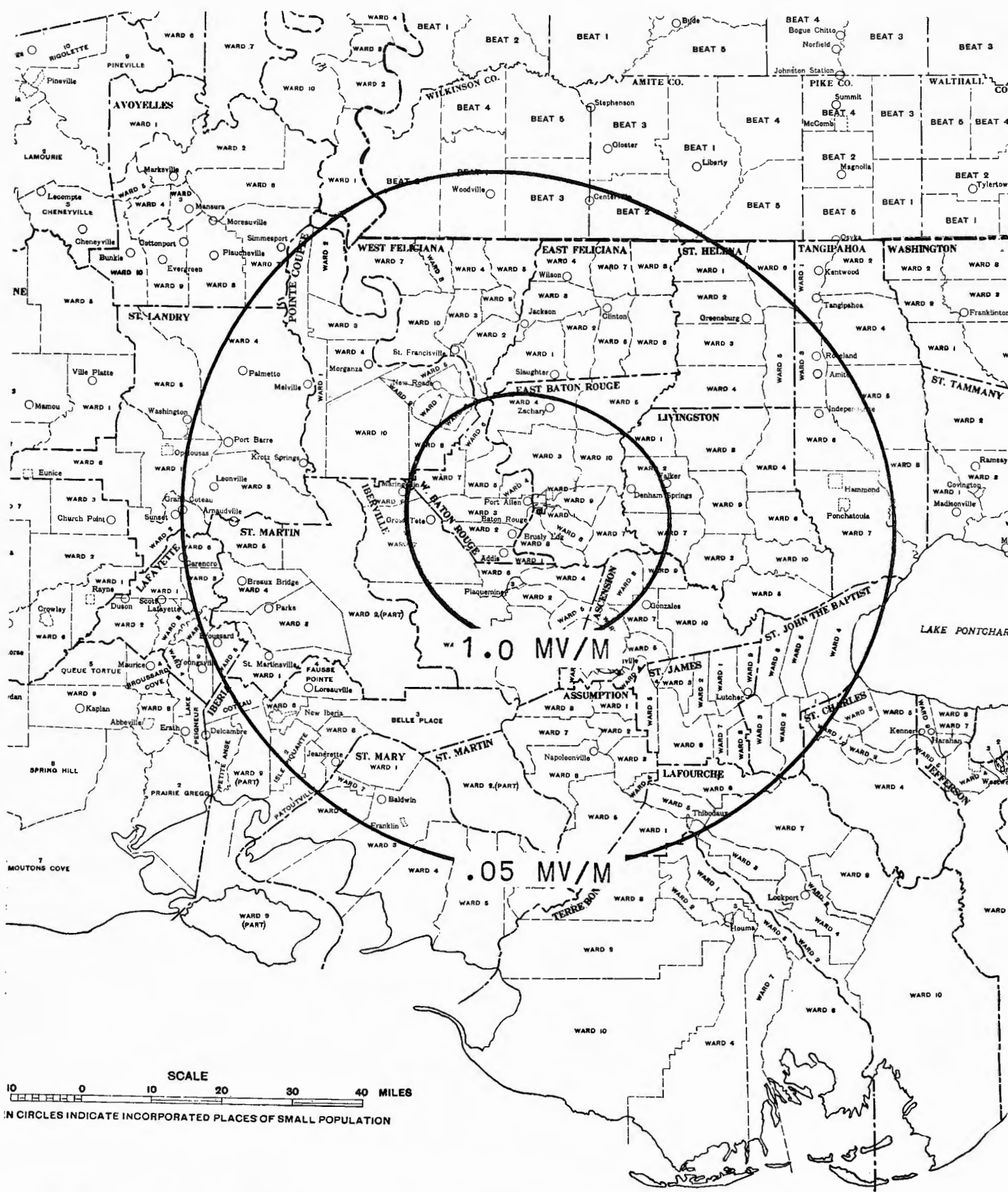

FIG. 2. A section of the Minor Civil Divisions Map for the State of Louisiana. The predicted 1 millivolt and .05 millivolt contours for a station located at Baton Rouge have been plotted from the data previously calculated. From this map the wards and parts of wards which will receive service are noted and the population of these determined from the Population Bulletin as shown in Table No. 3.

the procedure is to draw the eight radials on the Minor Civil Divisions Map and mark off on each of these the distances to the 1-millivolt and 50-microvolt points. The eight points of each contour are then connected by drawing a reasonably smooth curve through them. The WBRL map drawn in this manner is shown in Figure 2.

When the contours have been thus drawn, the next step is to list the wards (or precincts) and parts of wards included within each contour and add up the populations residing within these as given by the Population Bulletin. Table 3 illustrates the procedure.

In computing the population for wards (or precincts) only partly taken in by a given contour, a fraction of the population equal to the fraction of the total area included by the contour is used. For example, if it is obvious that some fraction, say two-thirds, of the area of a ward is included within the contour, then the proper procedure is to use two-thirds of the population of that ward as given by the Population Bulletin. An exception is made where it is obvious by inspection that an incorporated district, such as a city, is totally included (or totally excluded), in which case its population is included (or excluded) and the fraction of the area is applied only to the remainder of the ward population.

In computing the population within the 50 microvolt contour, "built-up city areas and business districts in cities having over 10,000 population and located beyond the 1000 uv/m contour" must be excluded since, according to FCC Standards, these areas require 1000 uv/m for satisfactory service.

The Minor Civil Divisions Maps and Population Bulletins used in making these determinations of population served can be obtained from the Superintendent of Documents, U. S. Government Printing Office, Washington, D. C. when not obtainable locally. There is a map and a bulletin for each state. These, of course, are based on the 1940 Census. If there is reason to believe that significant population shifts have occurred in the area since 1940 and supporting data is available, the newer figures may be used. Otherwise, the 1940 census figures should be used throughout.

TABLE NO. 3. POPULATION COUNT BY PARISHES

1 Millivolt Contour

West Baton Rouge	9,716
East Baton Rouge	67,204
Pointe Coupe	20,217
Iberville	17,886
Ascension	4,296
Livingston	3,472

TOTAL..... 122,791

50 Microvolt Contour

West Feliciana	10,924
East Feliciana	17,449
Pointe Coupe	21,007
St. Helena	8,492
East Baton Rouge	68,208
West Baton Rouge	9,716
Iberville	24,638
St. Martin	21,767
Assumption	15,990
Ascension	18,438
St. James	15,338
La Fourche	6,604
St. John The Baptist.....	14,078
Livingston	18,206
Tangipahoa	37,180
St. Mary	20,850
Iberia	4,603
Lafayette	6,252
St. Landry	20,623
Concordia	313
Avoylles	706

Total..... 361,382

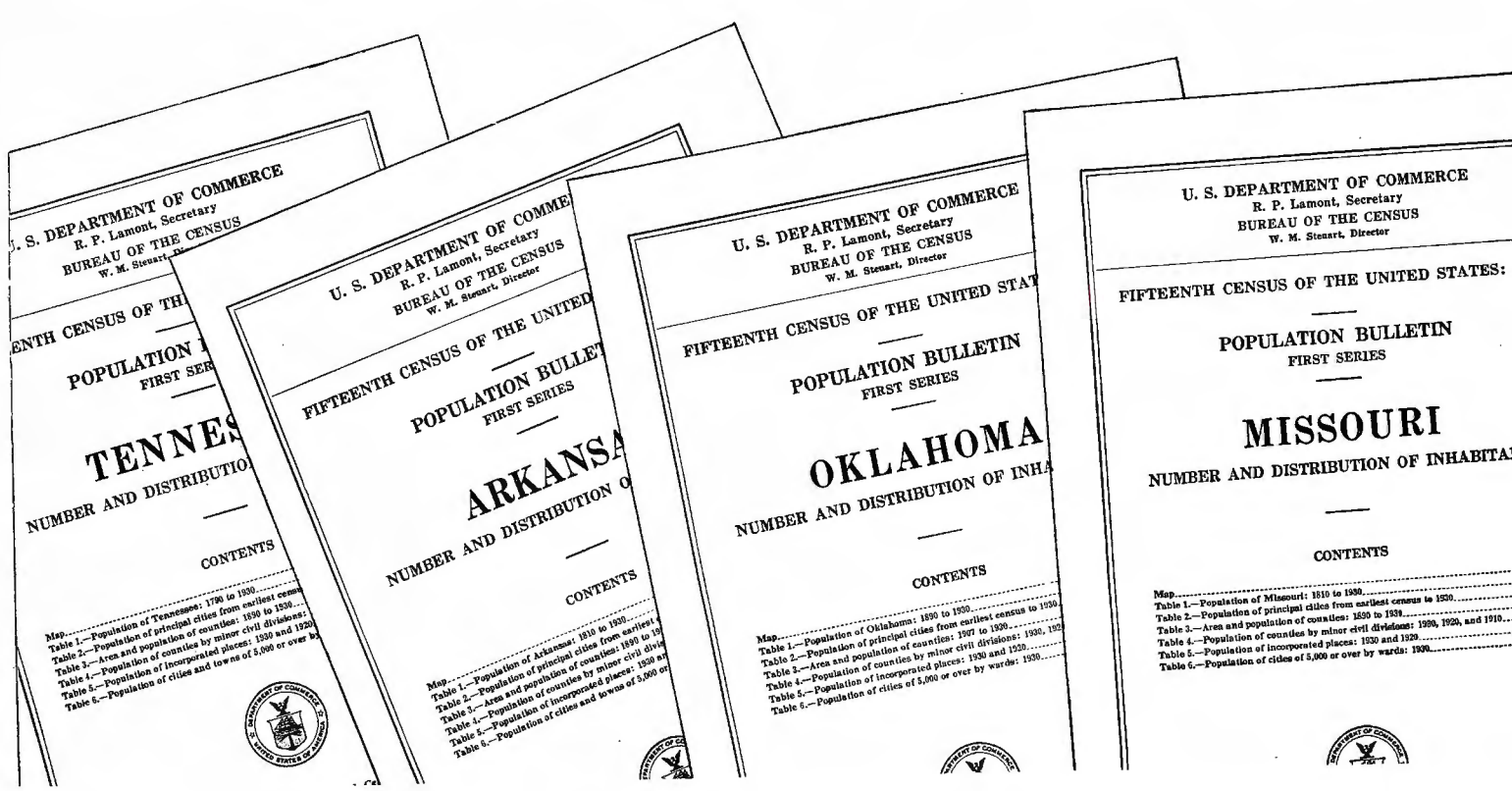

GROUNDING - GRID POWER AMPLIFIERS

Radio-Frequency Power Amplifiers Using Grounded-Grid Circuits Operate At Higher Frequencies And Can Handle Wider Bandwidths Than Capacitance-Neutralized Grounded-Cathode Circuits

By E. E. SPITZER

Engineering Department, RCA Victor Division

Power amplification at high frequencies has always been a difficult technical problem. As the frequency is increased, the problems become more difficult. A number of these problems can be alleviated by a novel circuit which, undoubtedly, is destined to be used widely in the high-frequency field. This circuit is often called the grounded-grid circuit, and while it is not new it has not until recently received the attention it deserves. The purpose of this article is to call attention to this circuit, point out its advantages and characteristics, and show how such a circuit is designed.

There are three practical ways of utilizing a triode as an amplifier. The most common way is to apply the input signal between grid and filament terminals and take output from plate and filament. A second way is to apply input to grid and plate and take output from filament and plate. This type of amplifier

is known as a cathode follower. The third way is to apply input to grid and filament and take output from plate and grid. There is no generally accepted name for this type of amplifier. It has been variously called grounded-grid amplifier, inverted amplifier, and common grid circuit because the grid is common to the input and output circuits. According to this terminology, the normal amplifier would be called a common cathode circuit, and the cathode follower would be a common plate circuit. In this article, the designation grounded-grid will be employed since it has been used fairly widely.

PROBLEMS OF TUBE DESIGN

Consider a normal triode circuit with input applied between grid and filament and a tuned output circuit between plate and filament. The filament is grounded. It is well known that such an amplifier will oscillate by itself at some undesired frequency because of feedback through the grid-plate capacitance of the tube. The cure for this difficulty is neutralization. However, as the frequency is increased, neutralization becomes increasingly difficult to handle. Because feedback is caused by capacitance between grid and plate and because any external neutralizing circuit is isolated from the internal capacitance by the inductances of grid and plate leads, the frequency band over which the tube can be neutralized becomes narrower and narrower with increasing frequency and finally vanishes altogether. Another undesirable effect is that capacitance neutralization serves to increase the input and output capacitances of the amplifier. For example a push-pull cross-neutralized amplifier has an output capacitance per tube equal to the plate-filament capacitance of the tube plus twice the grid-plate capacitance. This resultant high capacitance narrows the r-f bandwidth that can be handled or it may reduce the efficiency of the amplifier because of excessive circulating kilovoltamperes.

Tetrodes and pentodes were developed to overcome the foregoing difficulties. In these types of tubes, the screen and suppressor shield the control grid from the plate so that the feedback capacitance is low enough to make neutralization unnecessary. However, as the frequency is increased, self-oscillation may occur if the screen and suppressor leads have appreciable inductance. Then, these grids cannot be held effectively at r-f ground potential and, as a result, feed-through may occur. Twin tubes such as the RCA-829B were designed to overcome this difficulty. In a twin tube designed for push-pull operation, screen grids and cathodes can be intimately connected within the tube so that practically no inductance is present between these electrodes. Tubes of this design give excellent performance. The only difficulty is that tube cost for a twin-pentode tends to be

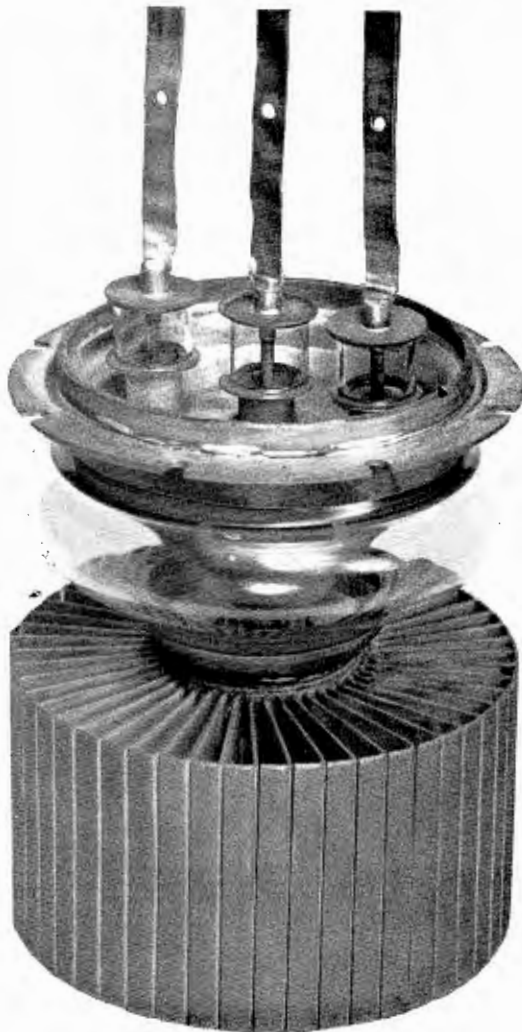

FIG. 1. (Left) The RCA-7C24, a triode especially designed for grounded-grid operation, is used in RCA FM Transmitters of all powers. (See "New FM Transmitters Now in Production," by R. J. Newman, BROADCAST NEWS, No. 42, January 1946.)

high compared to the cost of triodes or triodes for equivalent power output capability.

CIRCUIT CHARACTERISTICS

The grounded-grid circuit is a way of using a triode which reduces the possibility of self-oscillation without the need for neutralization. Figure 3 shows a grounded-grid amplifier circuit, in which the control grid acts as shield between plate and cathode to reduce feedback capacitance C_{PF} . Thus, the control grid performs one function of a screen grid in a tetrode.

A second characteristic of the ground-grid circuit is that the driver tube and output tube act in series to supply the load. In Figure 1, the driver produces an r-f voltage E_G across the input terminals of the output tube. The latter has an r-f voltage E_P across its plate and cathode. These voltages are 180 degrees out of phase with respect to the cathode so that the r-f voltage from plate to grid and also across the output circuit is $E_P + E_G$. If I_P is the fundamental component of plate current 180 degrees out of phase with E_P , and I_G is the fundamental component of grid current in phase with E_G , the following relations then hold

$$\begin{aligned} \text{Power delivered to load circuit} &= (E_P + E_G)I_P \\ \text{Power delivered by output tube} &= E_P I_P \\ \text{Driver power transferred to load circuit} &= E_G I_P \\ \text{Power delivered by driver circuit} &= E_G(I_P + I_G) \\ \text{Power absorbed by output tube} &= E_G I_G \end{aligned}$$

It is apparent from these relationships that driver tube and output tube act in series to supply the load circuit. Power output, therefore, is higher than would be expected and the conventional efficiency, based on the input to the output tube, is unusually high.

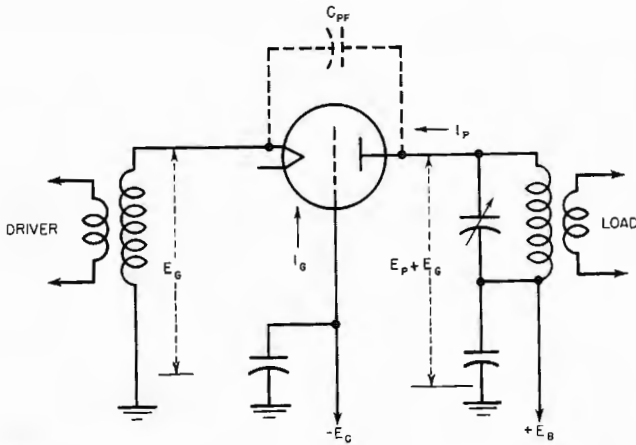

FIG. 3. Circuit and parameters of grounded-grid r-f power amplifier.

The foregoing discussion brings out a third characteristic. The driving power of a grounded-grid amplifier is higher than when the same tube is used in a normal triode circuit and may be three to ten times greater. However, this increased power is not lost; it is merely transferred to the plate circuit and appears as output, as explained above.

TUBES FOR GROUNDED-GRID CIRCUITS

A fourth characteristic is lower output capacitance: In a grounded-grid circuit, output capacitance is approximately C_{OP} , whereas in a normal capacitance-neutralized amplifier the output capacitance is more than twice this value. This fact is most important at high frequencies because lower output capacitance results in increased r-f bandwidth-handling capabilities and in lower circulating kva in the output circuits.

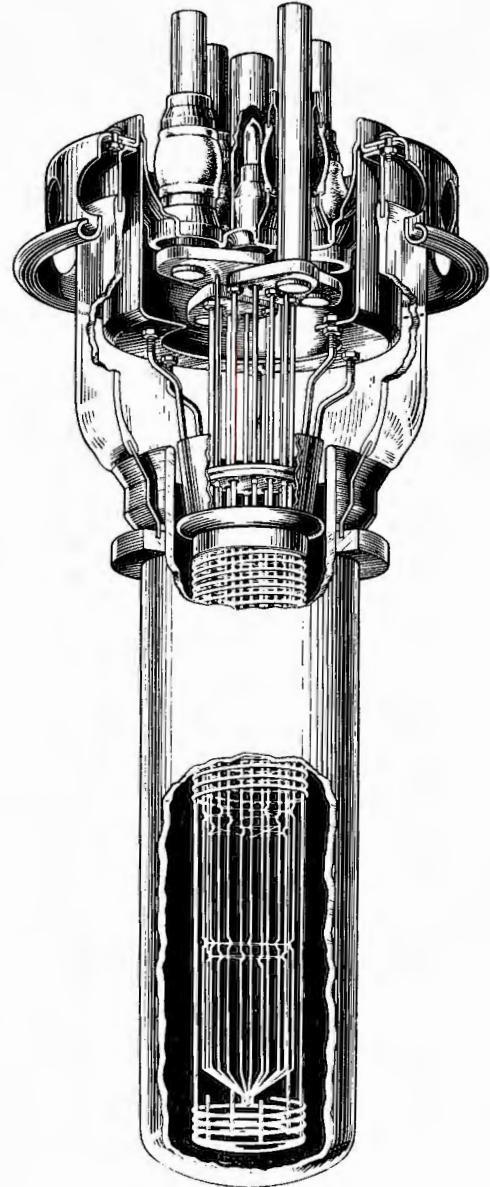

FIG. 2. Cut-away view showing method of extending grid cylinder to complete the shielding between filament and plate circuits in a triode especially designed for grounded-grid circuits.

All of the foregoing characteristics are advantageous with the exception of the increased driving power. The latter is a disadvantage because it may require more or bigger amplifier stages in the transmitter design. Because a pentode or beam tetrode does not have this disadvantage, the field of application of grounded-grid amplifiers is at frequencies at which pentodes are not available for the desired power, or where the cost of pentodes is greater than the cost of additional driving stages required by the grounded-grid circuit. Present indications are that the frequency and power boundaries are about as follows

Power in Kw	Frequency in Mc
0.1	300
25	30
100	10

For the stated power, the grounded-grid circuit becomes desirable at a frequency above that listed.

Most of the characteristics which make a triode desirable in a normal circuit also make it desirable in a grounded-grid cir-

Driving power = 1,800 w
Power output = 100 kw

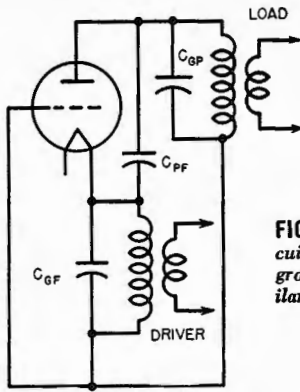

FIG. 4. Rearrangement of circuit of Figure 1 shows that the grounded-grid amplifier is similar to the Colpitts oscillator.

cuit. However, there are some additional requirements for a good grounded-grid tube. It has been stated above that the grid and its associated external ground plane should act as a screen between anode and cathode and their respective circuits. Therefore, the tube should be so designed that the anode and cathode connections are on opposite sides of the grid connection. For example, a tube which has an external anode with the grid terminal insulated from the other end is not at all suited for grounded-grid operation. On the other hand, a tube such as the 9C21 illustrated in Figure 2 is ideally suited for grounded-grid operation because the grid terminal is a large metal flange which can be connected to a metal shield separating the anode circuit from the cathode circuit. In addition, the grid support of the 9C21 has very low inductance and, therefore, meets the second requirement for a good grounded-grid triode.

Let it be required to design a grounded-grid stage utilizing one 9C21 triode. The tube will be used in the circuit shown in Figure 3. The manufacturer's data shows the following typical operating conditions for normal grounded-cathode circuits

- D-c plate voltage = 17,000 v
- D-c grid voltage = -1,600 v
- Peak r-f grid voltage = 2,200 v
- D-c plate current = 7.9 amp
- D-c grid current = 0.9 amp

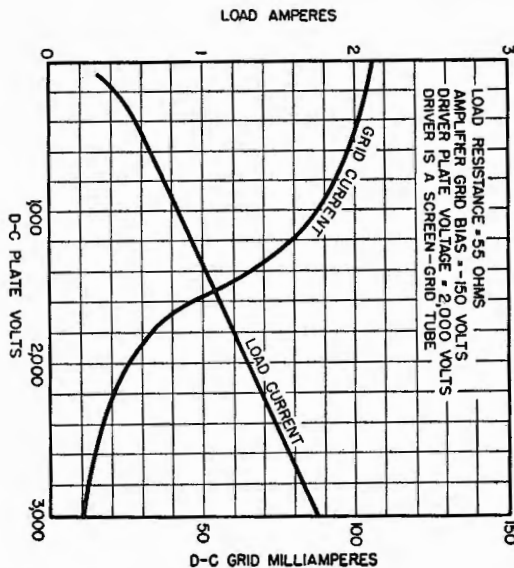

FIG. 5. Plate modulation characteristic of grounded-grid r-f amplifier.

AMPLIFIER DESIGN

It is first necessary to obtain the r-f plate voltage swing E_p . This can be estimated from the fact that in a properly excited class-C amplifier, the plate voltage will swing down to the value of the peak positive grid voltage. Because the value of the latter is equal to 2,200 minus 1,600 volts, or 600 volts, E_p is

$$2^{-1/2}(17,000 - 600) = 11,600 \text{ volts rms.}$$

Next, the fundamental components of plate current and of grid current must be obtained using the power output and driving power values given above

$$I_P = \frac{100,000}{11,600} = 8.63 \text{ amperes}$$

and

$$I_G = \frac{1,800 \sqrt{2}}{2,200} = 1.16 \text{ amp.}$$

The output power and the driving power of the grounded-grid stage can now be calculated from the relations given earlier. We obtain

$$\text{Power output} = (E_P + E_G) I_P$$

$$= \left(11,600 + \frac{2200}{\sqrt{2}} \right) 8.63 = 113 \text{ kw.}$$

$$\text{Driving power} = E_G (I_P + I_G)$$

$$\frac{2200}{\sqrt{2}} (8.63 + 1.16) = 15.2 \text{ kw}$$

It is possible to change the power output to some extent by varying the grid bias and the grid swing. For example, if the bias should be changed from -1,600 to -2,000 volts and the grid swing by a like amount, i.e., to 2,600 volts, the power output would be 116 kilowatts.

A grounded-grid amplifier stage can go into self-oscillation, particularly at high frequencies, because of feedback from plate to cathode through the plate-filament capacitance. This action is

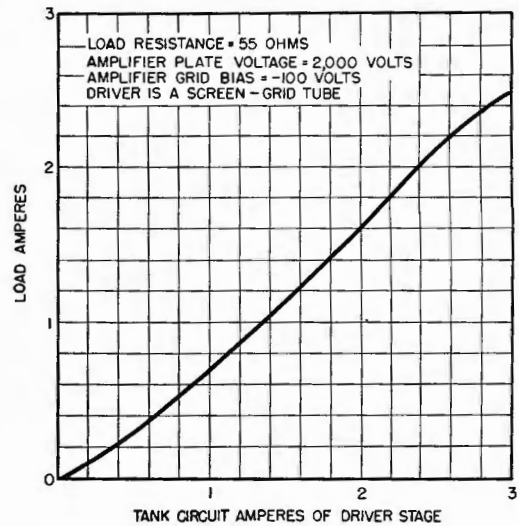

FIG. 6. Class-B power amplification characteristic of grounded-grid circuit.

more easily understood if the amplifier stage is redrawn as a Colpitts oscillator circuit, as shown in Figure 4. Because we are dealing with the worst conditions, inductive tuning only is assumed. The output circuit must be inductive at the oscillation frequency, as the following analysis proves.

CONDITIONS FOR OSCILLATION

It is well known that circuit reactance between filament and grid must be capacitive and, furthermore, should be at least one-fifth the reactance between plate and filament. This reactance will produce an excitation ratio, that is, a ratio of plate swing to grid swing, of five. In any good grounded-grid tube, the plate-filament capacitance will be so low that its ratio to the grid-filament capacitance will be much less than one-fifth. Thus, to produce oscillation, the input circuit must be inductive so as to reduce the effective capacitance between grid and filament to a value about five times that of the plate-filament capacitance. With tuned input circuits, this condition can easily be fulfilled. Let it be assumed that this condition is exactly fulfilled.

The total tank circuit capacitance is then

$$C_T = C_{PF} + \frac{C_{GP} + 5 C_{PF}}{5 C_{GP} C_{PF}}$$

In the case of 9C21, this capacitance would be

$$C_T = 1.8 + \frac{48 \times 5 \times 1.8}{48 \times 5 \times 1.8} = 9.4 \mu\text{f}$$

Thus for this 100-kw tube, the tank capacitance for parasitic oscillation is only 9.4 μf , a value which is quite small. This capacitance will store only appreciable amounts of power at high frequencies. Assume operation at a frequency of 20 mc. The reactance of C_T is then 850 ohms. If the tube is operated at 12 kilovolts with a plate swing of 11.6 kilovolts, the reactive power is $(11,600/2)^2/850 = 80$ kilovoltamperes.

We also know that oscillator stability necessitates an operating Q of at least 12. Therefore, in the above case, the circuit could be loaded to 6.7 kw. If all the circuit losses, including driving power and any power delivered to the load, are less than 6.7 kw, the tube will oscillate with certain adjustments of the input and output circuits. If we assume that the normal output circuit loss is five percent of 100 kw, or 5 kw, this value plus the driving power and the normal load coupled to the tube would be sufficient to make the amplifier stable at the assumed frequency.

MODULATION CHARACTERISTICS

When plate modulation of only a grounded-grid amplifier stage is attempted, a characteristic such as illustrated in Figure 4 is obtained. It will first be noted that grid current varies widely with plate voltage. As the plate voltage increases, the plate current also increases and causes an increasing load on the driver stage. Due to the regulation of the latter, driving voltage decreases and with it grid current. This decrease of grid current is quite large and is characteristic of this type of amplifier.

Over quite a range of plate voltage, the output current is linear with plate voltage as in the case of conventional class C amplifiers. However, at low voltages load current departs from linearity and will not be zero until negative values of plate voltage are reached. This phenomenon is due to the fact that r-f driving voltage and d-c plate supply voltage are in series as shown in

Figure 1. As a result the plate not only has a d-c supply voltage but also simultaneously an r-f supply voltage. Therefore, the plate current and the load current do not drop to zero until a value of negative plate voltage equal to the value of the peak driving voltage is reached. Accordingly, the resultant characteristic of modulating only a grounded-grid stage shows distortion unless one is satisfied with partial modulation. To obtain a modulation characteristic which will permit 100-percent modulation, it would be necessary to modulate simultaneously one or more successive stages.

The above problem is of little practical consequence because amplitude modulation is rarely used at the high frequencies for which the grounded-grid circuit is particularly applicable. The problem does not exist for such services as frequency-modulation, television and industrial power.

When a grounded-grid amplifier is used as a linear, class-B r-f amplifier, quite satisfactory results are obtained, as shown in Figure 5. Such an amplifier could be used to amplify television signals.

Bibliography.

- (1) Alexanderson, E. F. W., U. S. Patent 1,896,534, filed May 13, 1927, granted Feb. 7, 1933.
- (2) Spitzer, E. E., "Grounded-Grid Operation of Triodes as Class B and C Amplifiers," an unpublished report dated Dec. 22, 1930.
- (3) Lindenblad, N. E., U. S. Patent 2,136,448, filed Apr. 14, 1932, granted Nov. 15, 1938.
- (4) Romander, H., "The Inverted Ultraudition Amplifier," *Q.S.T.*, p. 14, Sept. 1933.
- (5) Potter, R. K., U. S. Patent 2,088,722, filed June 12, 1936, granted Aug. 3, 1937.
- (6) Strong, C. E., The Inverted Amplifier, *ELECTRONICS*, p. 14, July 1940.
- (7) Labin, E., Design of the Output Stage of a High Power Television Transmitter, *Electrical Communication*, 20, No. 3, p. 193, 1942.
- (8) Gurewitsch, A. M., Cavity Oscillator Circuits, *ELECTRONICS*, p. 135, Feb. 1946.



"That cheese company's putting on a very realistic program lately."

" G R O U N D E D G R I D "

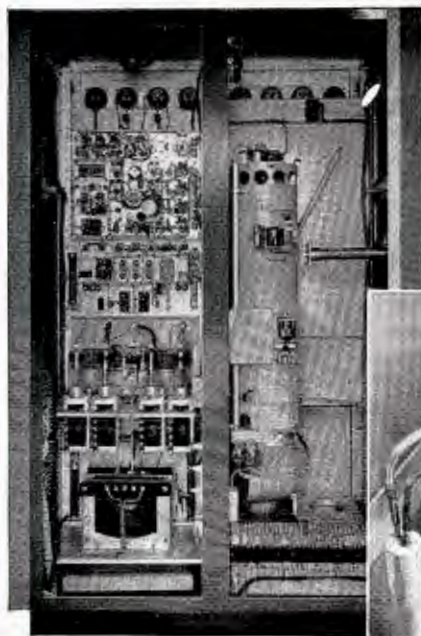
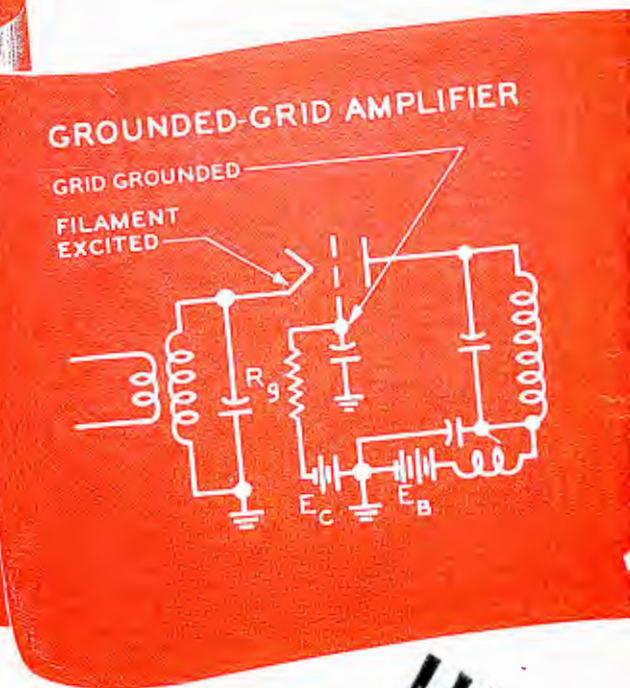
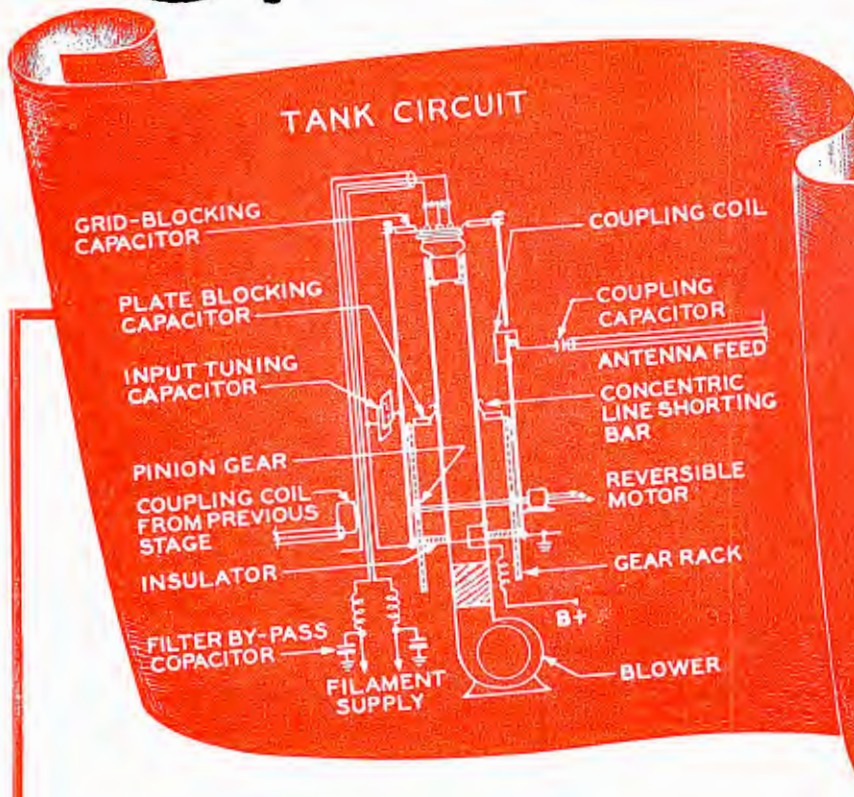

Amplifier tank assembly (right half of unit at left)—Visible are outer conductor of concentric-line plate tank, cathode transmission line at left, and motors to adjust cathode line, plate tank, and output coupling loop. Close-up below shows the RCA-7C24 in position, grid and filament clamps and connections, and air scoop to cool the tube seals.

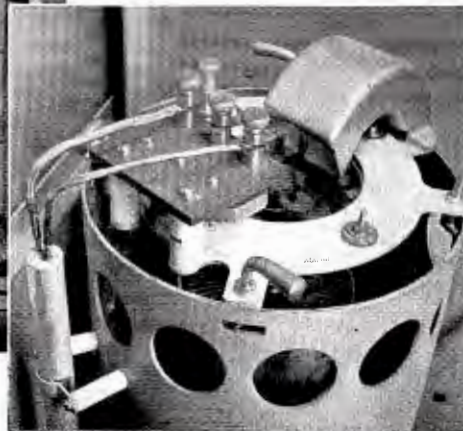

Tube and grid-clamp assembly—The new RCA-7C24 (top) is a forced-air-cooled triode especially developed to get the most out of Grounded-Grid circuits. (Plate dissipation: 2-kw at frequencies up to 110 mc; power output: 4-kw at 110 mc, class C service.) The flange ring at the top of glass envelope is the grid terminal (a glass-to-metal seal). The grid support is conical in shape and extends well into the tube to provide complete shielding between filament and plate circuits. The circular grid clamp (right) is used to make connection to the disk-seal flange of the grid. With the tube and grid clamp in position (above, left), plate and filament circuits are effectively isolated and a direct, low-inductance path is provided to the grid. No neutralization is needed.

for greatest stability

... adds these *plus values* to the new

RCA FM TRANSMITTERS

CONVENTIONAL AMPLIFIER

FILAMENT GROUNDED
GRID EXCITED

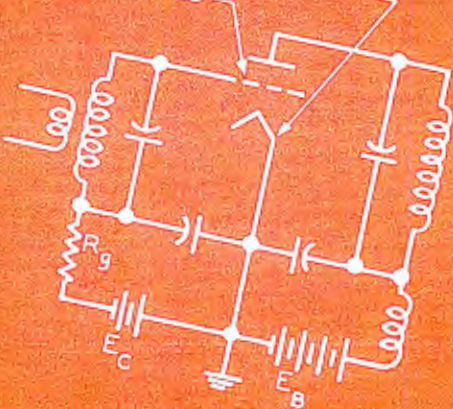

- ✓ No neutralization is required for low-power transmitter ratings and it is an easy matter if ever required on high-power transmitters.
- ✓ Simpler circuits with fewer components than conventional amplifiers. Tune easier, introduce less distortion, and assure better program quality.
- ✓ Stability and lack of critical adjustment not previously obtained in 100-mc transmitters.
- ✓ Easier to increase power. You only have to buy the *additional* power required (i.e. a 250-watt transmitter plus a 750-watt amplifier equals a 1000-watt transmitter)—more efficient than adding a 1000-watt unit as is the case with conventional amplifiers.
- ✓ Smaller, less expensive tube types are required since greater output is obtained from the amplifier using a tube of a given size.
- ✓ Fewer spare tubes needed inasmuch as the same tube types are used in the driver and power amplifier of the 1-kw and 3-kw stages.

THE NEW RCA Grounded-Grid amplifier circuits are at once simpler and more stable than any heretofore used. As the name indicates, the grid of the tube is at r-f ground potential (instead of the filament as in conventional amplifiers). Input is applied to grid and filament and output is taken from plate and grid.

Using specially developed triodes (RCA-7C24's), RCA Grounded-Grid circuits are distinguished, principally, by these characteristics:

1. The possibility of self-oscillation has been reduced. Neutralization is seldom required.
2. The driver tube and output tube act in series to supply the load, greatly increasing the over-all efficiency when compared with the efficiency of conventional amplifiers.
3. Driving power required in Grounded-Grid circuits is higher than that in conventional amplifier circuits. But this power is not lost—it is merely transferred to the plate circuit and appears as output.
4. Lower output capacitance (approximately 16 mmfd C_{gp} as contrasted with more than twice this value in capacitance-neutralized amplifiers)—important to assure wide r-f bandwidth and low circulating kva in output circuits.

Add to these advantages the benefits derived from our "Direct FM" exciter circuit, and you will see why we believe an RCA FM Transmitter will mean money in your pocket and true "FM quality." Write Dept. 19-G1, Broadcast Equipment Section, Radio Corporation of America, Camden, New Jersey.



BROADCAST EQUIPMENT
RADIO CORPORATION of AMERICA
ENGINEERING PRODUCTS DEPARTMENT, CAMDEN, N.J.

In Canada: RCA VICTOR Company Limited, Montreal

How to buy an FM TRANSMITTER

RCA's new "add-an-amplifier" designs help you cut costs today, make power increase easy tomorrow

THE matched units which make up RCA's new line of FM transmitters are *all the same size* (25 by 25 by 84 inches) — a big help in reducing installation problems and expenses.

Each unit is relatively light and can be easily handled by two men using a small "dolly" or hand truck. They can be taken through an ordinary door or carried up on a passenger elevator.

As indicated below, higher power units can be easily added at any time without making any of the original equipment obsolete, and without spoiling the transmitter's unified appearance. Thus you can get your FM station started *now*—even if you do not know what your ultimate power requirements will be.

A new-type, hollow base frame provides space for inter-unit wiring, and eliminates the need of wiring through units or conduits in the floor.

New "Direct FM" and "Grounded Grid" circuits (simpler and more stable than any heretofore employed) offer other advantages such as easier tuning, smaller, less-expensive tubes, lower operating costs, less distortion, and better frequency response.

We believe that these FM transmitters are the finest ever offered to broadcasters. Write today for full information. Radio Corporation of America, Dept. 18-DI, Engineering Products Department, Camden, N. J.



The new RCA 10-kw FM transmitter, showing how the equal-size units fit together. Curved end pieces and continuous trim strips (not shown) add to transmitter's unified appearance.

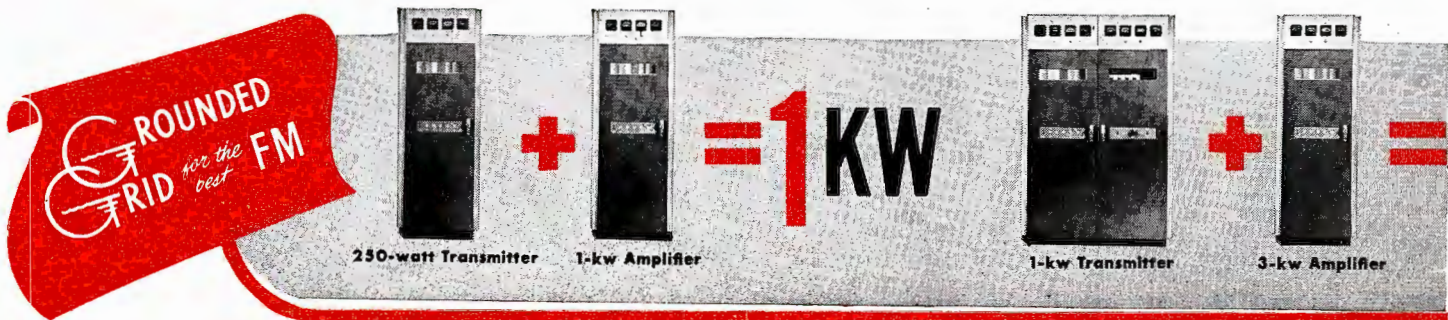

with an eye to the future . . .

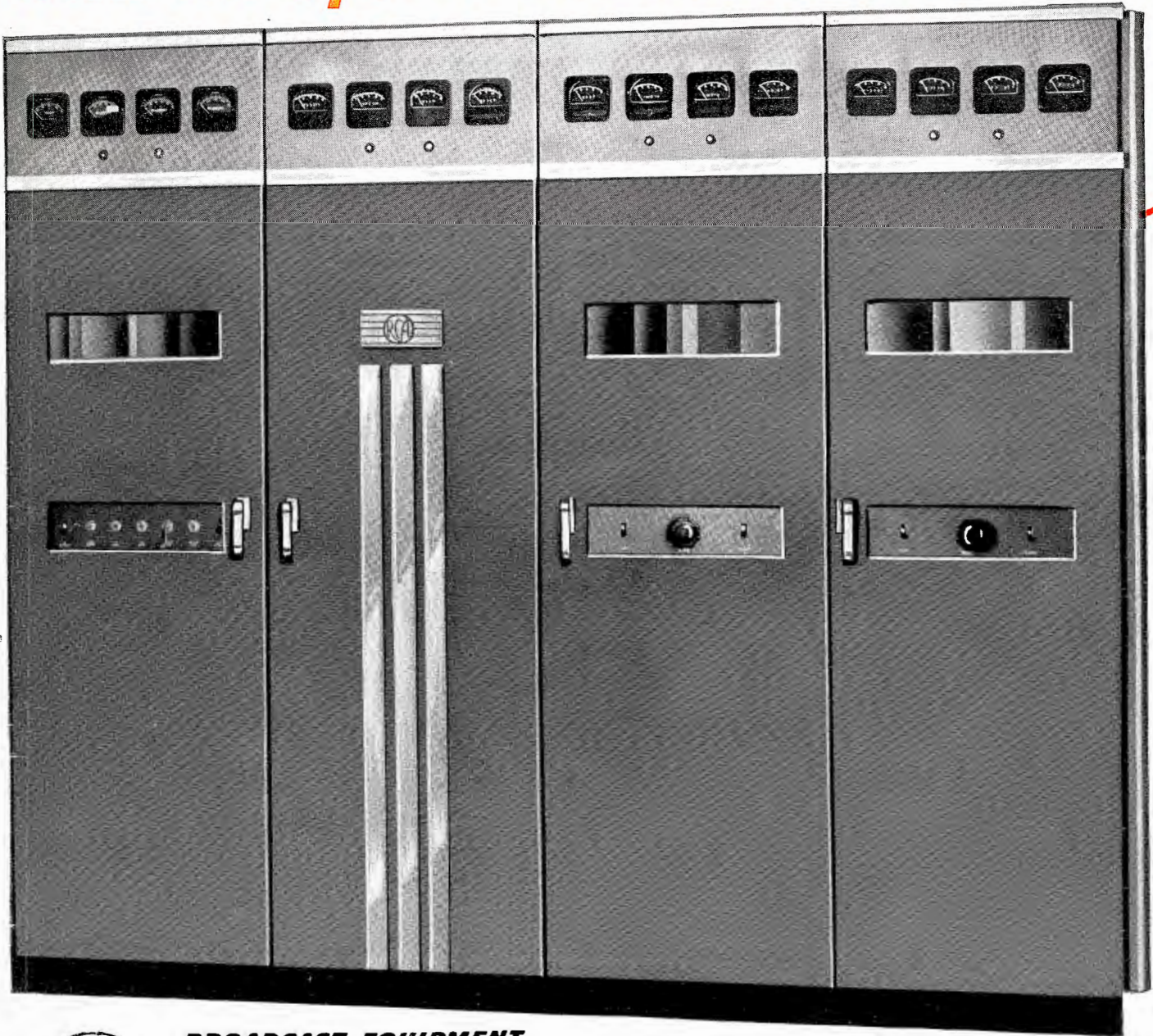

BROADCAST EQUIPMENT

RADIO CORPORATION of AMERICA

ENGINEERING PRODUCTS DEPARTMENT, CAMDEN, N.J.

3 KW

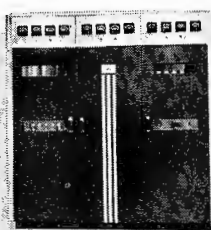

3-kw Transmitter

+



10-kw Amplifier

=

10 KW



The TK-30 Television Camera in the Studio . . . See Pg. 8